

narbutas

# COMBUS

More than just a shelf



COMBUS

# A vision of the modern office

- Spaces that meet the different needs of the employees



- A stylish environment that reflects the comfort of home



- Sustainable choices



COMBUS

# COMBUS – modular shelving system for shaping spaces



COMBUS

# Different types for different needs



Shelving unit for mounting on cabinets



Shelving unit



Planter shelf unit

COMBUS

# Product features

- A wide range of functionalities.
- Easily adaptable design.
- Environmentally friendly.



A wide range of functionalities

COMBUS

# A variety of forms for different office settings



COMBUS

# Division of spaces to ensure the appropriate level of privacy





COMBUS

# Convenient storage of items



COMBUS

# Integrating plants into the office environment



COMBUS

# Conference wall for high-quality meetings



COMBUS

# Aesthetic electrical solutions of the conference wall

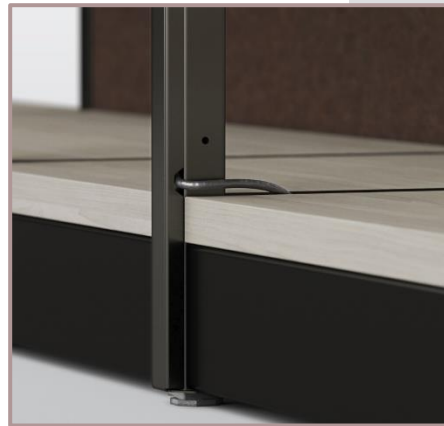

# Easily adaptable design

COMBUS



COMBUS



COMBUS





COMBUS

# Design elements that create character

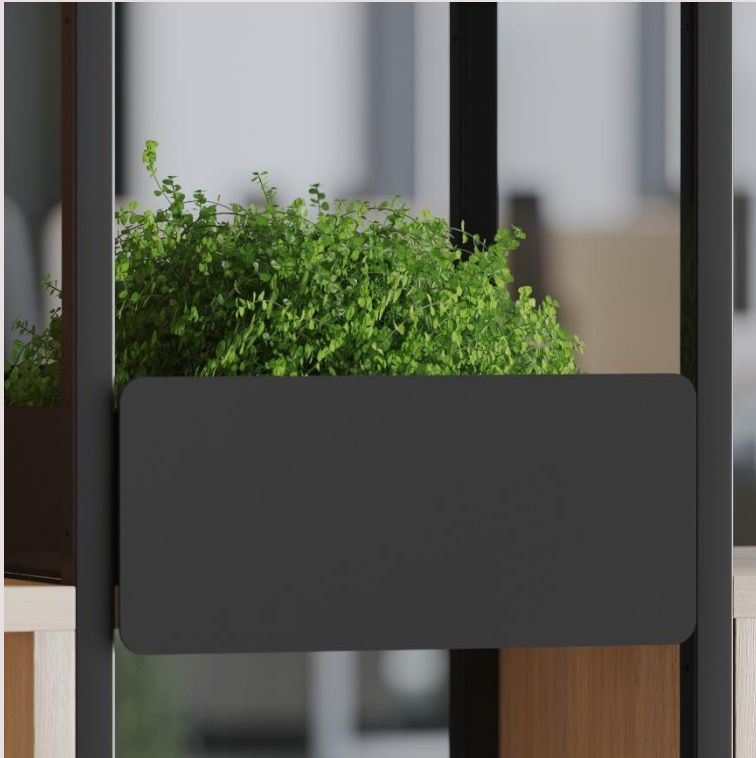

Metal planter box



PET felt basket



Metal book-end

COMBUS

# Various back panels

Perforated metal

Melamine

PET felt



COMBUS

# The play of different finishes



COMBUS

Environmentally friendly

# Eco-design principles

- Just the necessary amount of material.
- Recycled materials.
- Possibility to disassemble, upgrade and recycle.



# COMBUS



## COMBUS consists of three main materials



### Metal

- Made from  $\leq 100\%$  recycled materials.
- Powder coating with low VOC emissions.



### Melamine

- Made from  $\sim 25\%$  recycled materials.
- It is low in formaldehyde emissions and complies with the CARB 2 and E05 standards.



### PET felt

- Made from  $\geq 50\%$  recycled materials.

# When relevance of the product changes

- It is easy to upgrade a modular furniture.
- Possible disassembly up to a 99%.
- Recyclability up to 99%.

COMBUS





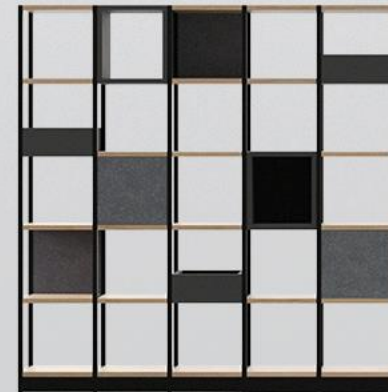



# Easily create your COMBUS





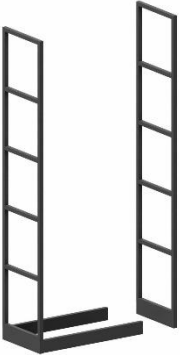
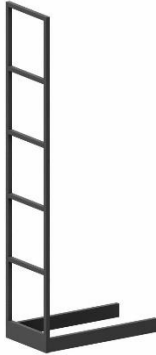



















COMBUS shelving units

	Start and end modules	Extension modules	Connecting elements	Accessories
Width: 400 mm	<p>3H/4H/5H/6H</p> 	<p>3H/4H/5H/6H</p> 		
Width: 800 mm	<p>3H/4H/5H/6H</p> 	<p>3H/4H/5H/6H</p> 	 <p>Only 3H and 4H</p>	

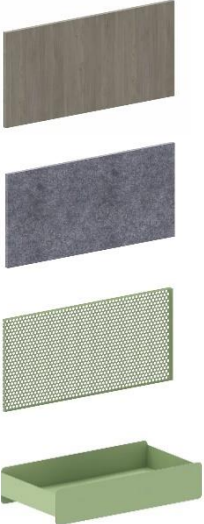
COMBUS planter shelf units

	Planter box	Planter box and shelves	Planter box and drawer	Accessories
2H		-	-	-
3H	-			
4H	-			

COMBUS shelving units for mounting on cabinets

	Shelves	Planter boxes and shelves	Boxes and shelves	Accessories
2H				<p>400 mm</p>  
3H				<p>800 mm</p>   
4H				

COMBUS

nSpace<sup>•</sup>

You can easily order this product on the nSpace platform, where you will also find the most popular COMBUS combinations ready to order.

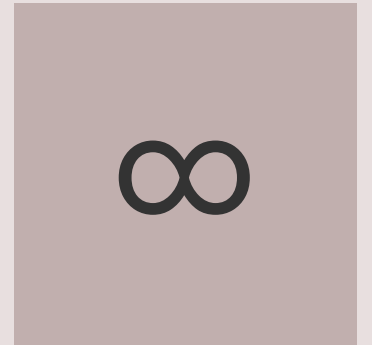
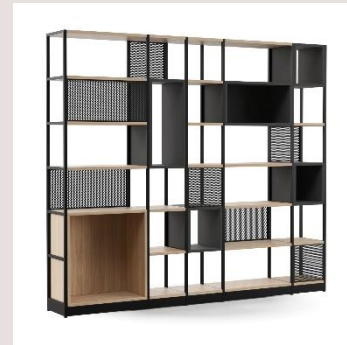
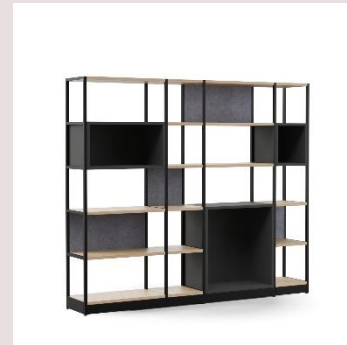
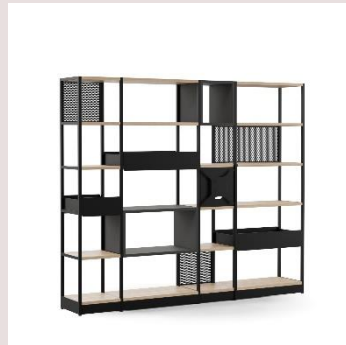
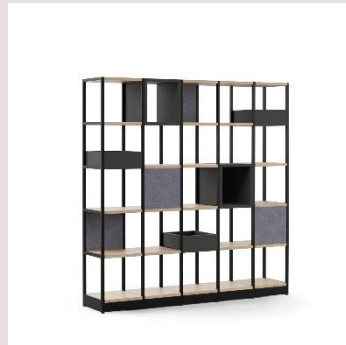
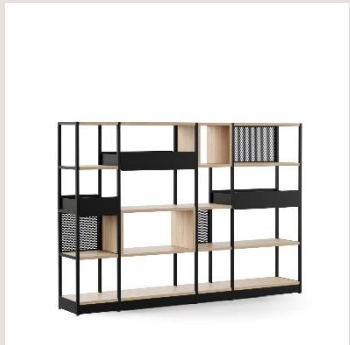
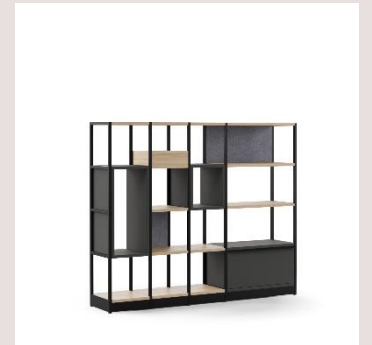
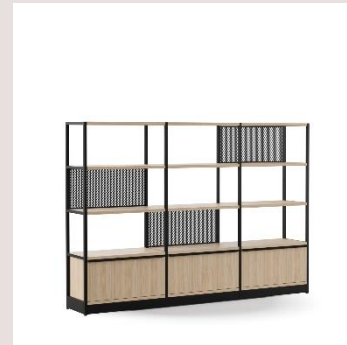
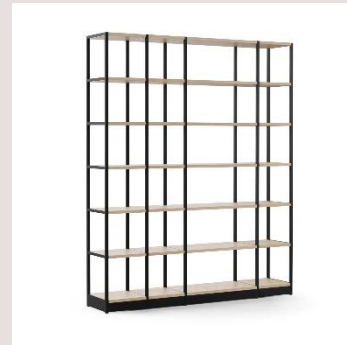
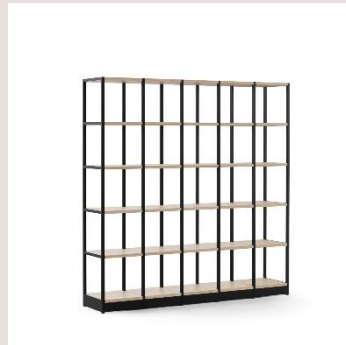
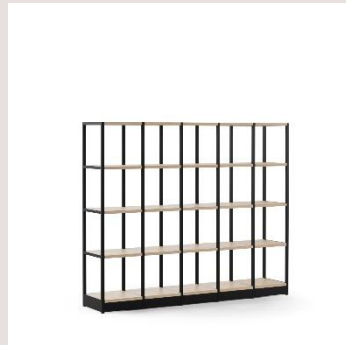
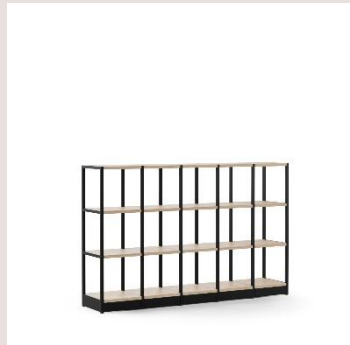

narbutas



narbutas.com

ANDO