



FELTOUCH

Aesthetically Acoustic Solutions!

feltouch.com

FELTOUCH

Aesthetically Acoustic Solutions!

Feltouch provides high performance acoustic absorbers using unique & smart designs for all interior spaces to improve speech intelligibility, well being, concentration and performance.

Feltouch offer wall panels, wall cladding, ceiling solutions separators, table dividers and LED lighting through our range of standard or fully customised solutions tailored to projects.

We are highly aware of our responsibility to the environment and work hard to minimize the environmental impact of all our manufacturing and business practices. We try to save and keep our world how it is naturally. We are proud to represent a sustainable economy by using recycled, eco-friendly and harmless to human health raw materials throughout our production process.

We have a limitless will to work alongside architects, interior designers and facility managers to offer the best possible acoustic and decorative outcome for interiors.

FELTOUCH DESIGNS;

High Acoustic performance (EN-11654) up to class A

Fire Retardant and self-extinguishing (EN-13501) B,S1,d0

Low VOC, formaldehyde-free (ISO-14184)

Superior thermal insulating 0,040 W/mK

Light fastness grade 6+ (ISO-105 B02)

%99.9 Antibacterial structure (ISO-20743)

Long lasting moulded and resistant to impact, moisture and humidity

Compared to alternative materials; they are extremely lightweight, apx.1,5kg / M2

Designed for easy assembly and installation

Easy to clean with a damp cloth or vacuum cleaner

Aesthetically Acoustic Solutions

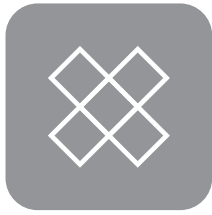

Wall Panel



Ceiling Panel

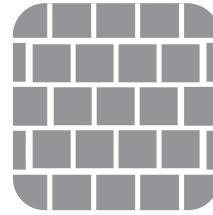

Cladding

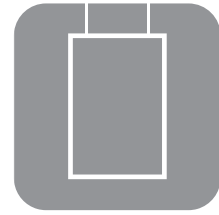

Hanging



Furniture

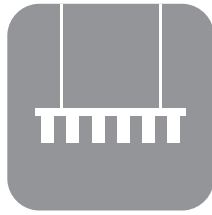

Ceiling

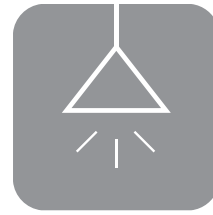

Lighting

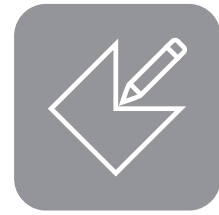

Customizable

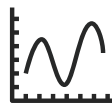

High Acoustic Performance

ISO 11654 - EN 354 A class NRC rates between 250hz and 5000hz



Decorative & Suitable

More than many colour options and unique design



Eco-Friendly & Healthy

Recycled PET and no chemical binders, low VOC.



Innovative & Creative

Turkey's first and leading company in acoustic PETfelt production for interiors.



Easy to Install & Lightweight

Smart installation and average weight 1500gr/m2



Flammability Performance

EN 13501-1, SBI TEST

FIRE BEHAVIOUR	SMOKE PRODUCTION			FLAMING DROPLETS		
B	-	s	1	,	d	0

FELTOUCH

SENSE

COLLECTION

DESIGNED BY YIGIT OZER

Sense Collection approaches PET felt design in a whole new perspective. The distinguished design has been implemented by Feltouch felt which developed to meet environmental norms in line with interior building standards.

Sense Collection presents the largest panels created by using pressed PET felt technology. Visual varieties and individually customizable arrangements of acoustic panel series creates stunning vertical and horizontal optical patterns. Designs adaptable panel surfaces enables extensive creative freedom to differentiate and cover many surfaces from ceilings to walls and corners through its unique 3D patterns, mono and corner forms.

Acoustical space separation of Diagon enhances many varieties of living areas through interior spaces to many architecturally variable solutions by the 3 dimensional concave and convex surface design. Unique rotational system design allows extensive creative freedom to separate, isolate or exposing spaces whenever needed.

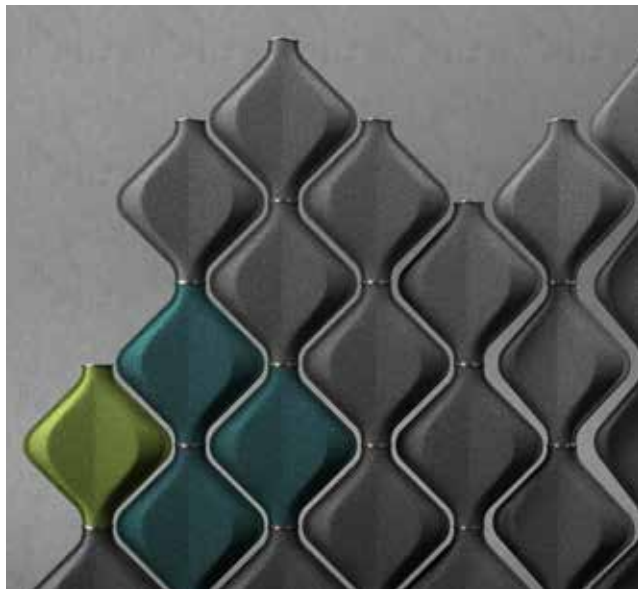

Diagon



Vertigo

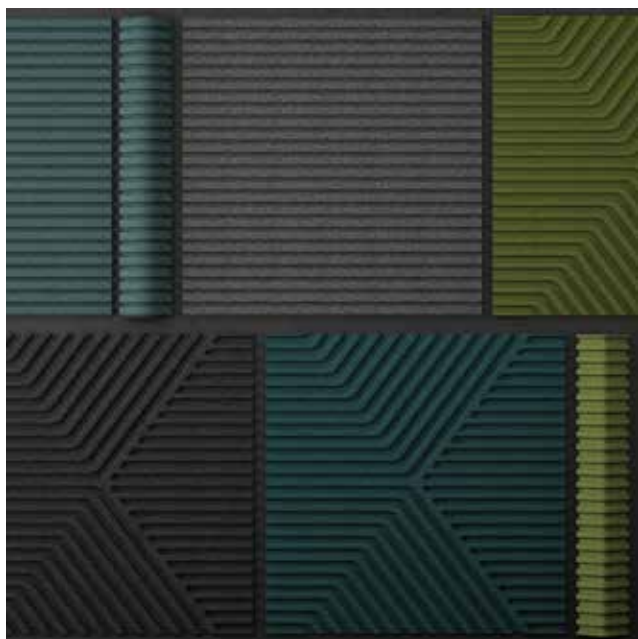

Parallax



Diagon



Furniture Solutions

Dimensions

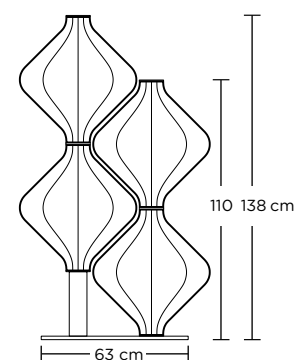
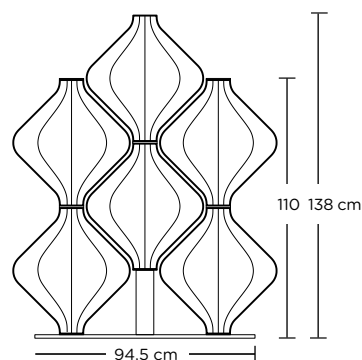
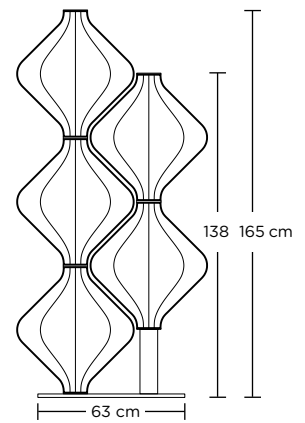
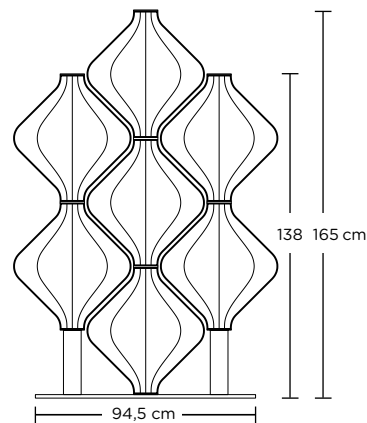
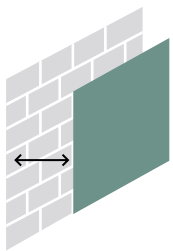
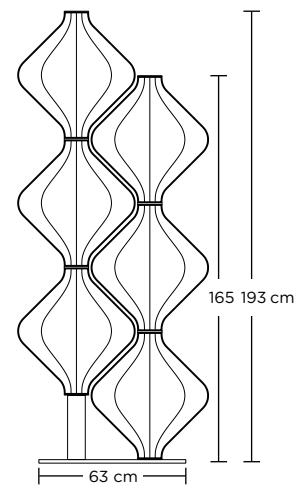
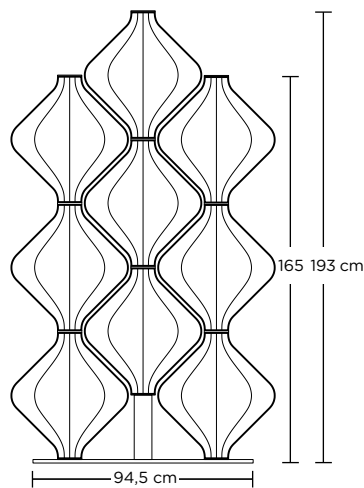
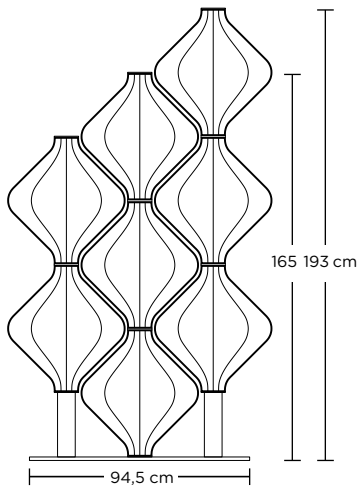
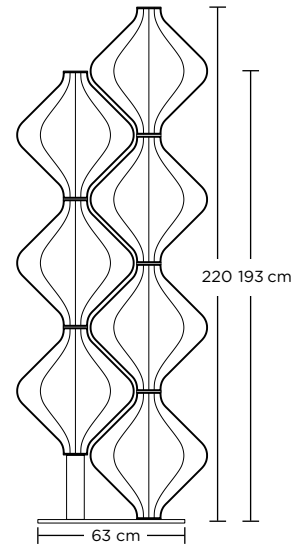
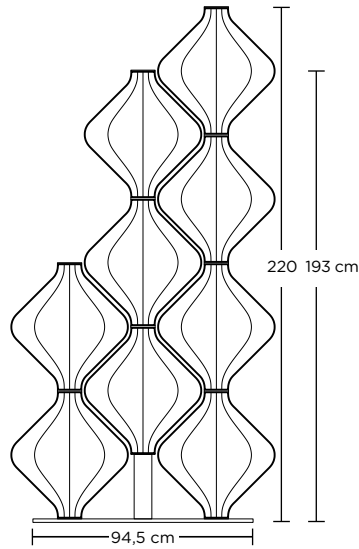
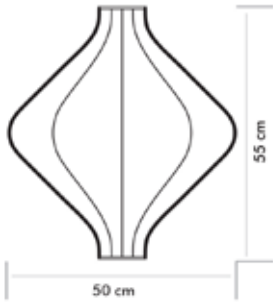

	Standart
NRC	0.81
α_{ω}	0.85
Class	B

Sound absorption coefficient measurements and calculations according to TS EN ISO 354 and TS EN ISO 11654 standards.

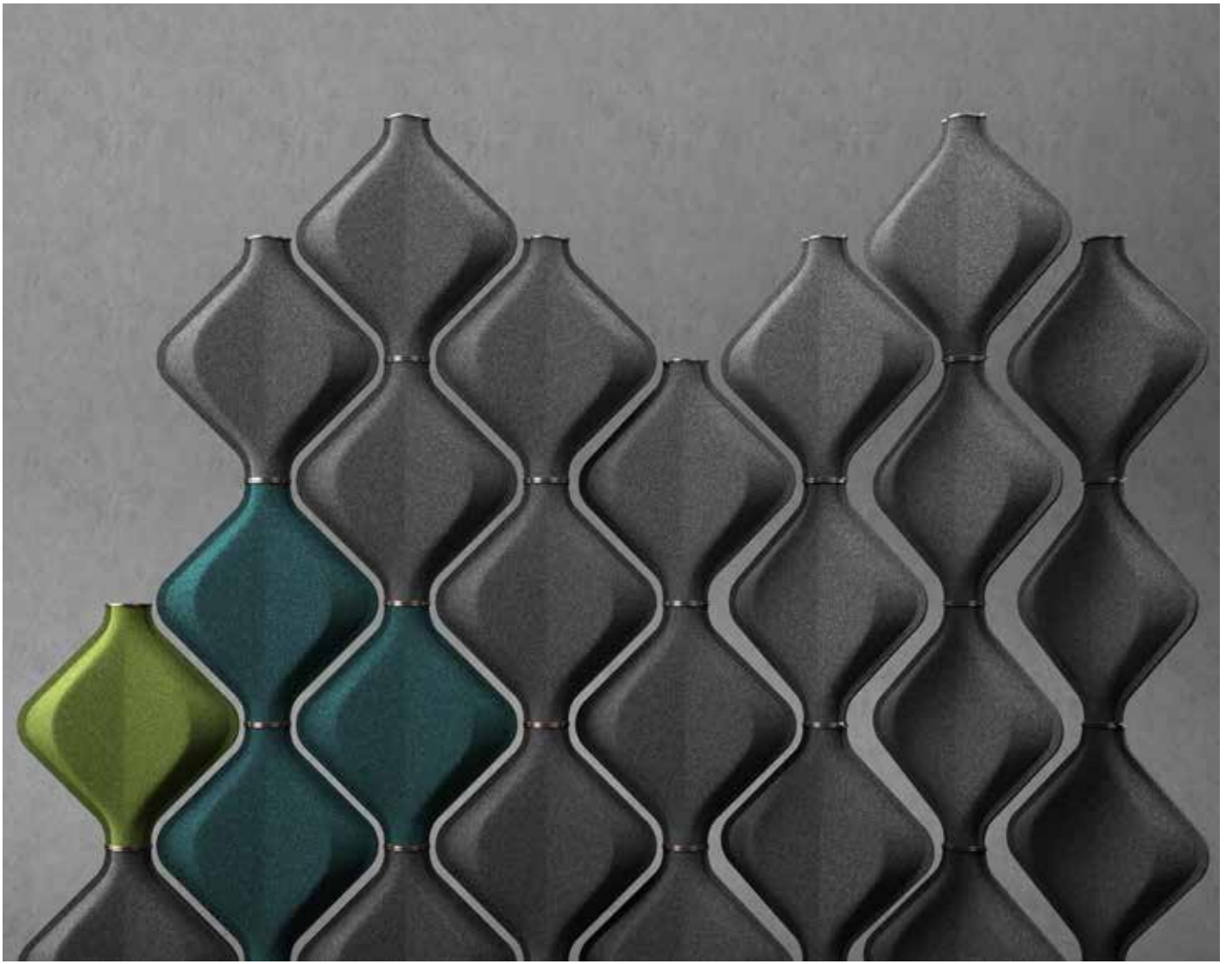

Vertigo

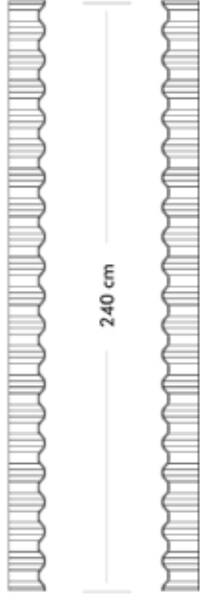
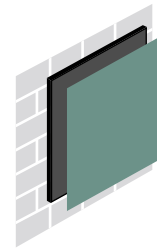
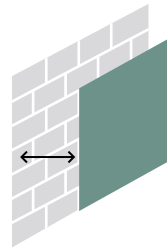
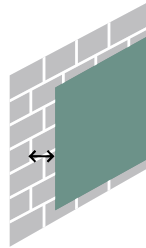
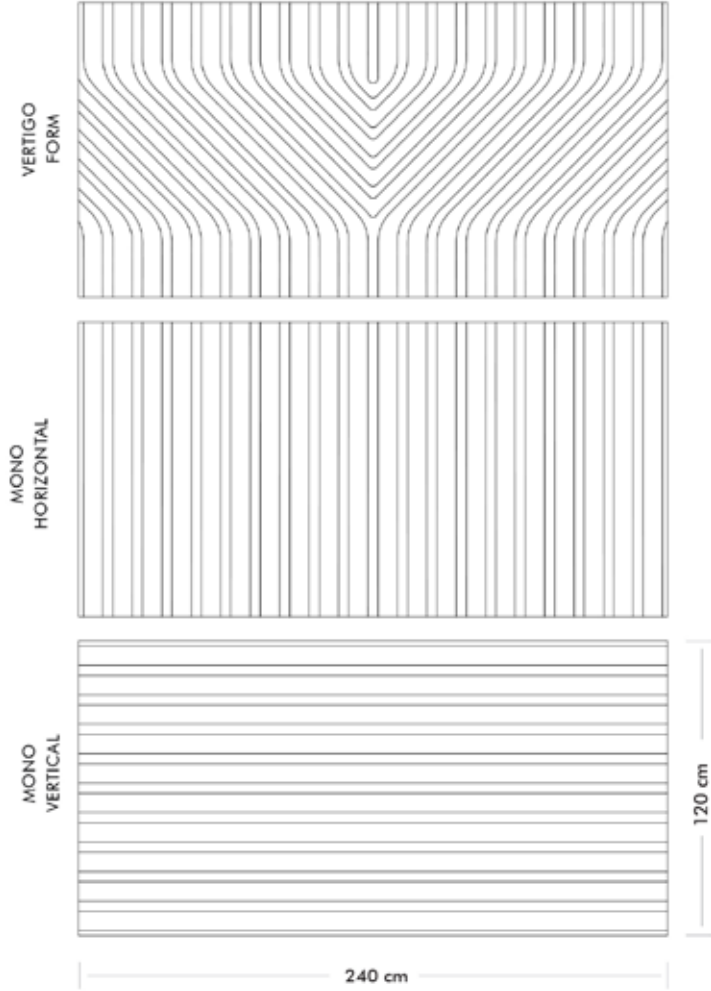
Wall Panel
SolutionsCeiling Panel
SolutionsCORNER
OUTCORNER
INFor color
swatch card

	Standart	30mm GAP	50mm GAP	30mm Rock Wool
NRC	0.45	0.60	0.63	0.77
α_{ω_0}	0.35	0.45	0.50	0.70
Class	D	D	D	C

Ses yutim katsayısı ölçüm ve hesaplamaları TS EN ISO 354 ve TS EN ISO 11654 standartlarına göre yapılmıştır.
Sound absorption coefficient measurements and calculations according to TS EN ISO 354 and TS EN ISO 11654 standards.

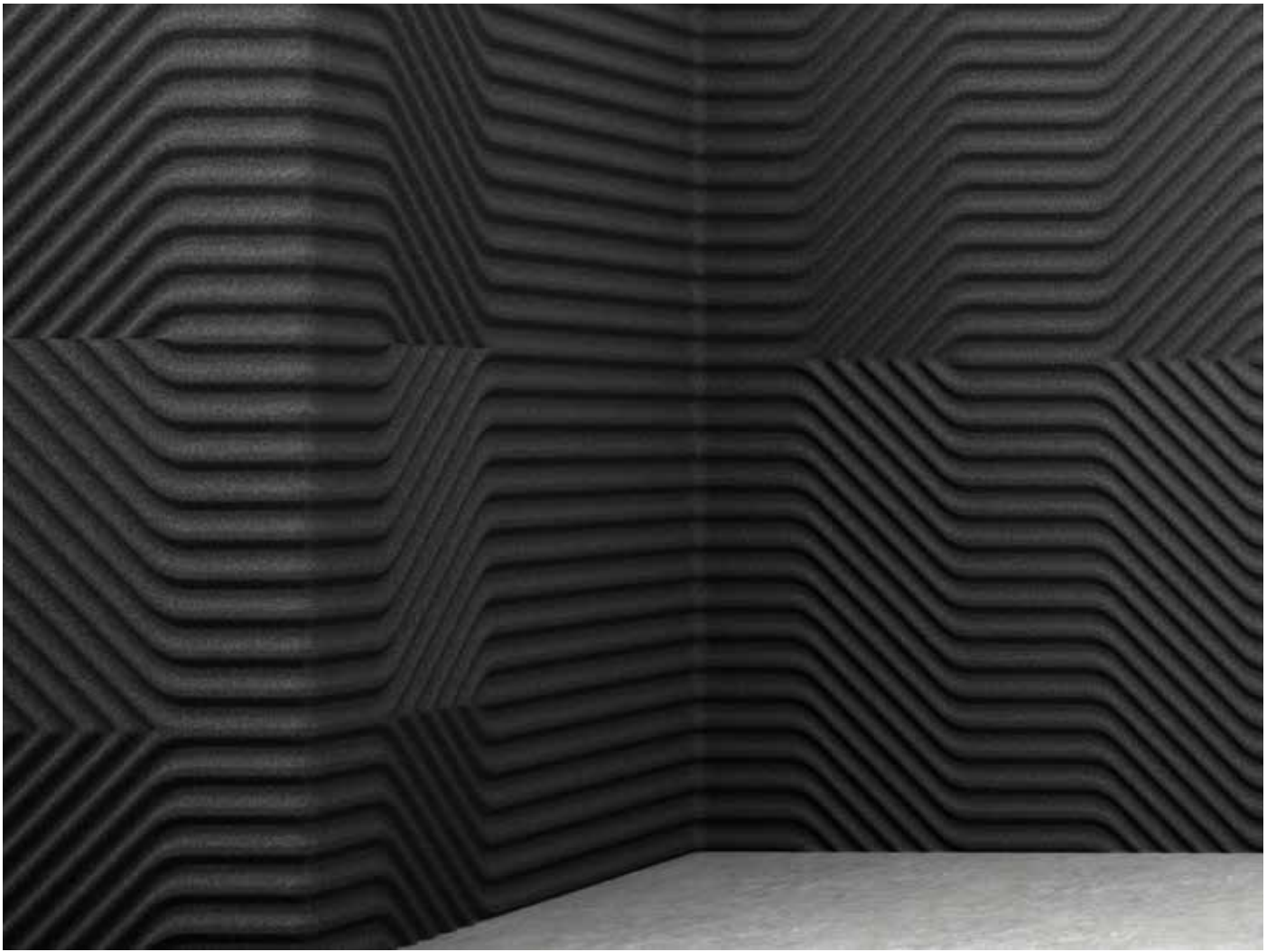

Parallax

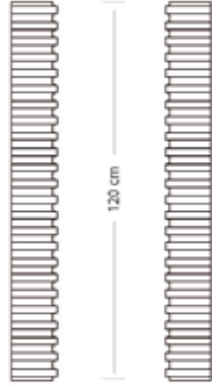
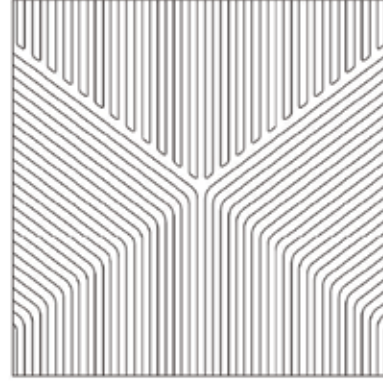
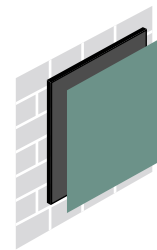
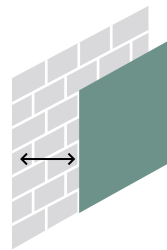
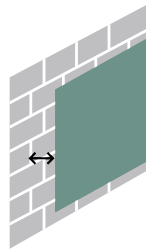
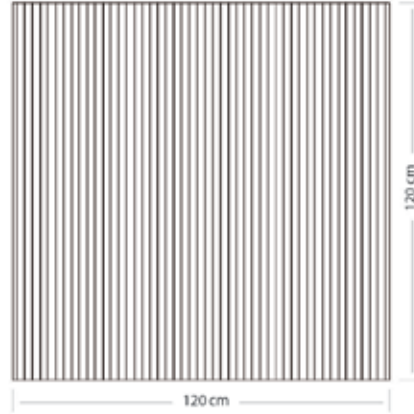
Wall Panel
SolutionsCeiling Panel
SolutionsFor color
swatch cardPARALLAX
FORBAPARALLAX
MONO

	Standart	30mm GAP	50mm GAP	30mm Rock Wool
NRC	0.40	0.59	0.63	0.76
α_{ω_0}	0.25	0.45	0.50	0.70
Class	D	D	D	C

Ses yutım katsayısı ölçüm ve hesaplamaları TS EN ISO 354 ve TS EN ISO 11654 standartlarına göre yapılmıştır.
Sound absorption coefficient measurements and calculations according to TS EN ISO 354 and TS EN ISO 11654 standards.

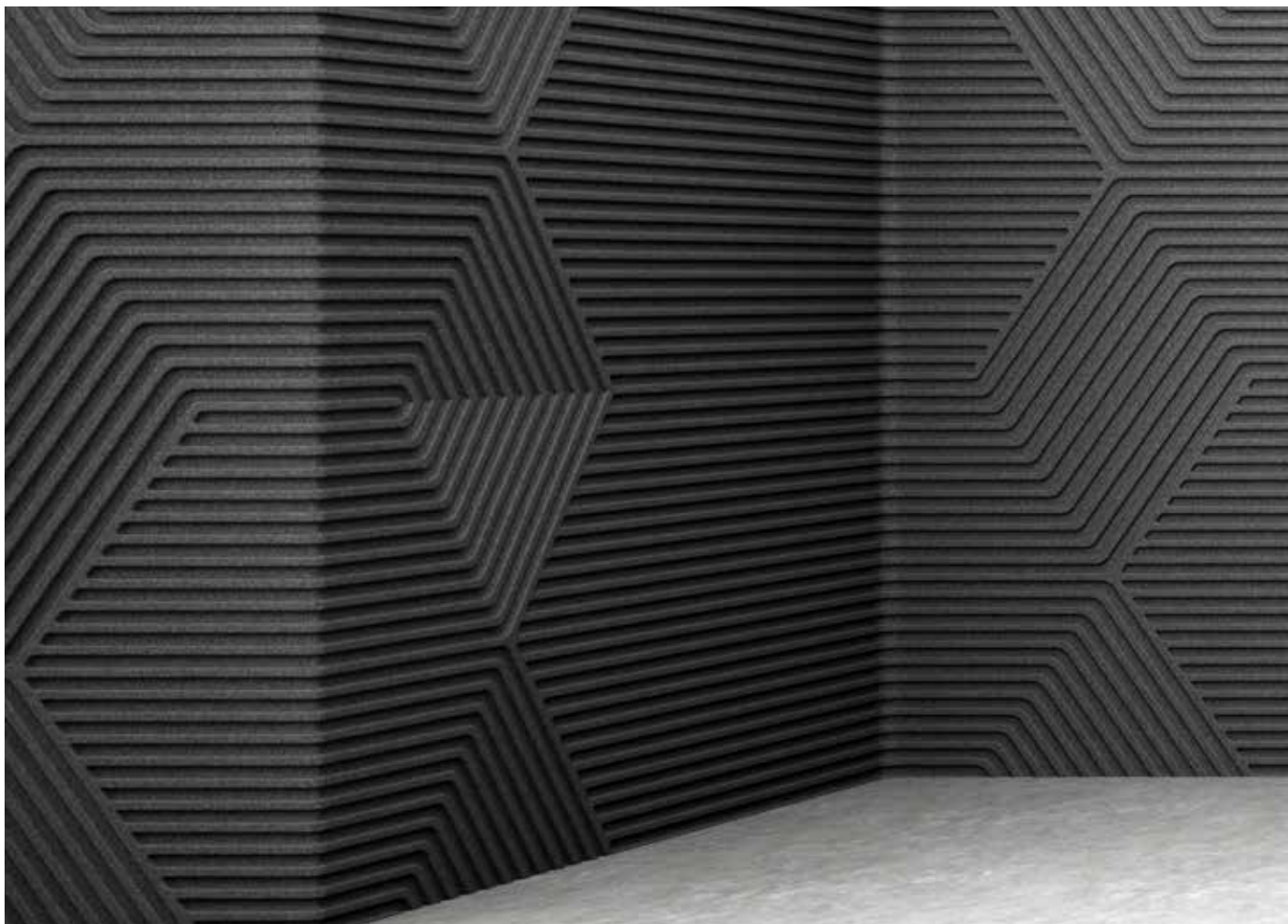

FELTOUCH

DecoSound

Premium acoustic Solutions for your interiors!

DecoSound Panel Collection provides decorative premium acoustic solutions up to A class high acoustic performance for your interior spaces with unique 3D designed 8 models, many dimension alternatives and colour options.

Products are lightweight, semi-rigid, pin-receptive acoustic panels which are easy to assemble with smart installation options. The velour vertiface finish produces a highend luxury look and feel. Using the smart installation options, you can easily alternate colour combinations or change the design periodically.



Batura



Frequency

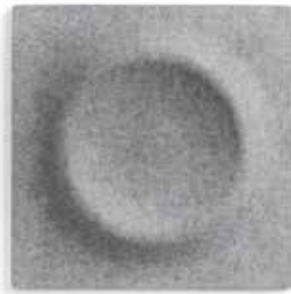

Octopus



Rhino Square



Rhino Triangle



Manta



Spider Web



Parallels

BATURA

Wall Panel
SolutionsCeiling Panel
Solutions

Dimensions

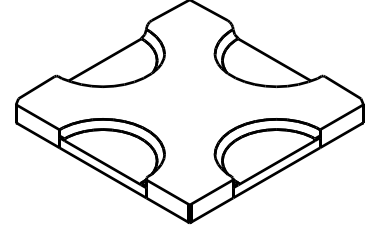
50 cm x 50 cm
60 cm x 60 cm

APPLICATION EXAMPLES

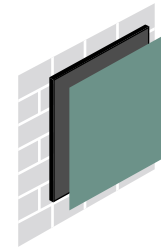
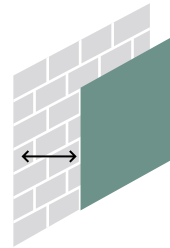
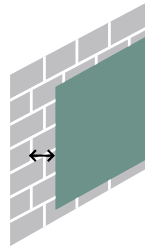
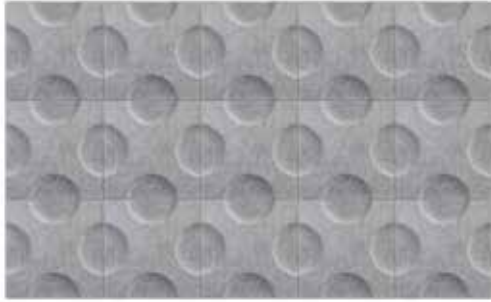

	Standart	30mm GAP	50mm GAP	30mm Rock Wool
NRC	0.79	0.81	0.83	0.85
α_{100}	0.80	0.85	0.85	0.90
Class	B	B	B	A

Ses yutim katsayısı ölçüm ve hesaplamaları TS EN ISO 354 ve TS EN ISO 11654 standartlarına göre yapılmıştır.
Sound absorption coefficient measurements and calculations according to TS EN ISO 354 and TS EN ISO 11654 standards.

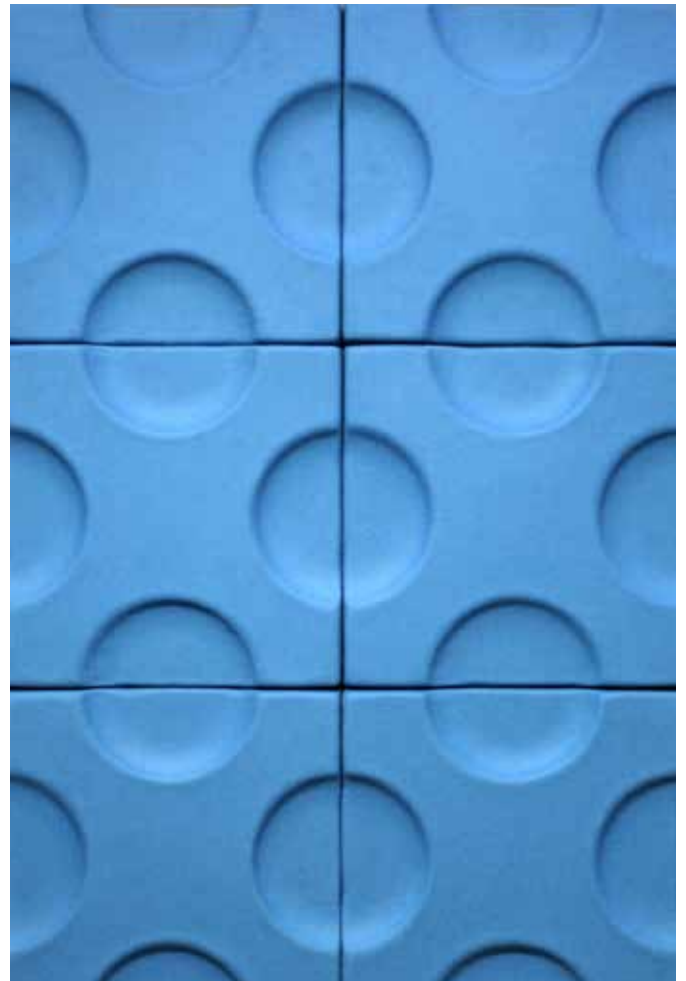

Fethiye Barut Sensatori

FREQUENCY

Wall Panel
SolutionsCeiling Panel
Solutions

Dimensions

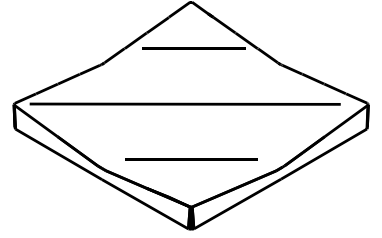
50 cm x 50 cm
60 cm x 60 cm

APPLICATION EXAMPLES

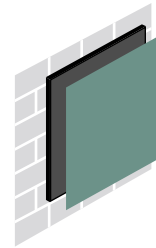
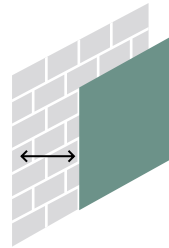
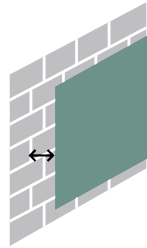
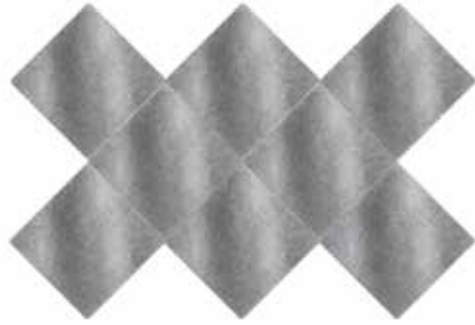
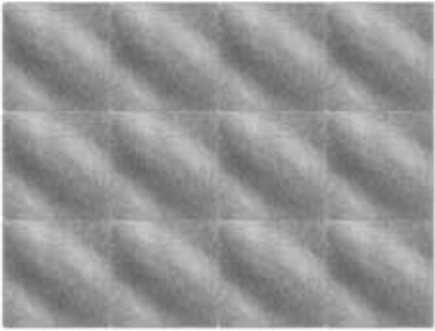

	Standart	30mm GAP	50mm GAP	30mm Rock Wool
NRC	0.79	0.81	0.82	0.85
α_{w0}	0.80	0.80	0.85	0.90
Class	B	B	B	A

Ses yutüm katsayısı ölçüm ve hesaplamaları TS EN ISO 354 ve TS EN ISO 11654 standartlarına göre yapılmıştır.
Sound absorption coefficient measurements and calculations according to TS EN ISO 354 and TS EN ISO 11654 standards.



Asia Ofis Park Meeting Rooms

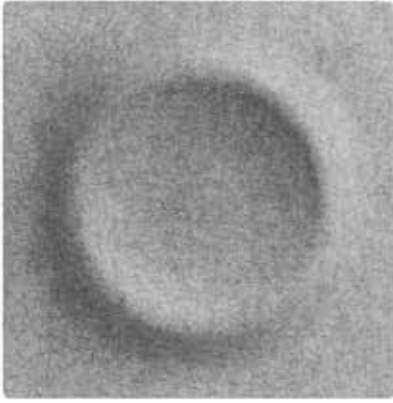

OCTOPUS

Wall Panel
SolutionsCeiling Panel
Solutions

Dimensions

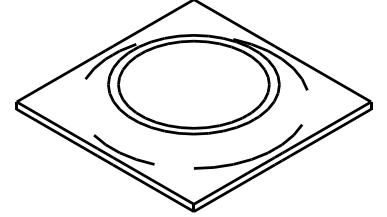
50 cm x 50 cm
60 cm x 60 cm

APPLICATION EXAMPLES

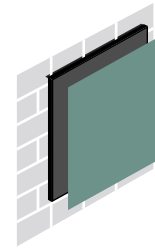
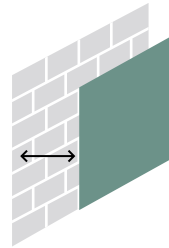
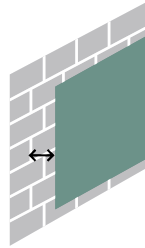
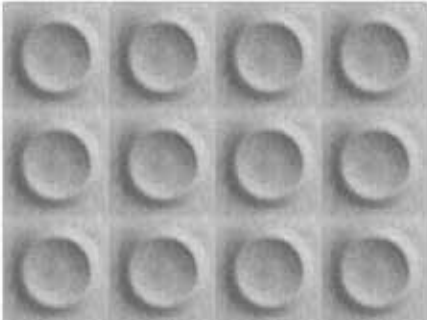

	Standart	30mm GAP	50mm GAP	30mm Rock Wool
NRC	0.78	0.80	0.81	0.85
α_{ω}	0.80	0.80	0.85	0.90
Class	B	B	B	A

Ses yutüm katsayısı ölçüm ve hesaplamaları TS EN ISO 354 ve TS EN ISO 11654 standartlarına göre yapılmıştır.
Sound absorption coefficient measurements and calculations according to TS EN ISO 354 and TS EN ISO 11654 standards.



Siemens R&D Campus

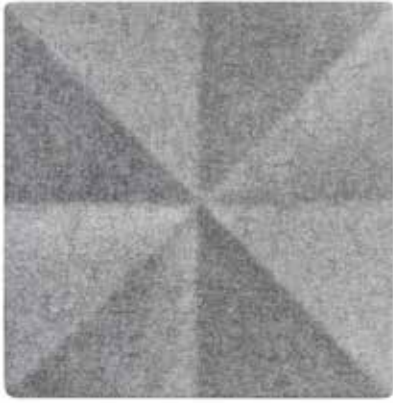

RHINO SQUARE

Wall Panel
SolutionsCeiling Panel
Solutions

Dimensions

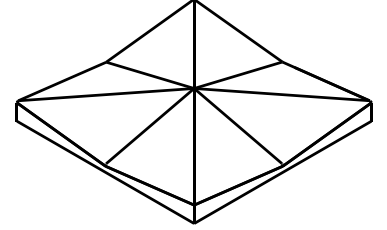
50 cm x 50 cm
60 cm x 60 cm

APPLICATION EXAMPLES

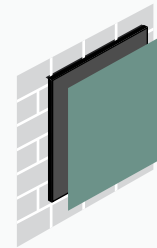
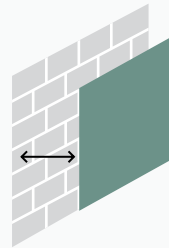
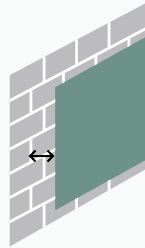
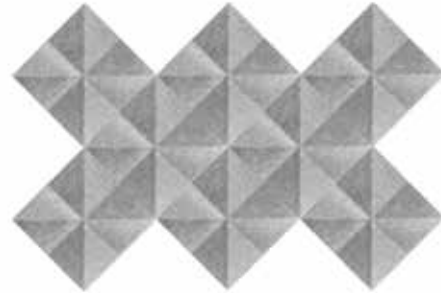
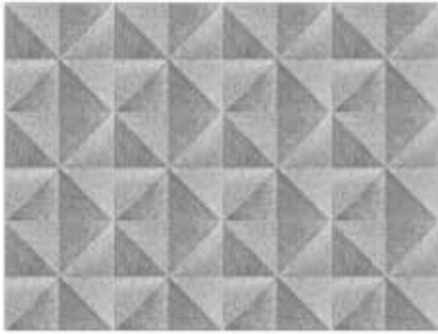

	Standart	30mm GAP	50mm GAP	30mm Rock Wool
NRC	0.81	0.83	0.84	0.86
α_{ω_0}	0.85	0.85	0.90	0.90
Class	B	B	A	A

Ses yutim katsayısı ölçüm ve hesaplamaları TS EN ISO 354 ve TS EN ISO 11654 standartlarına göre yapılmıştır.
Sound absorption coefficient measurements and calculations according to TS EN ISO 354 and TS EN ISO 11654 standards.



Biletix

RHINO TRIANGLE

Arkitera İnce Yapı
Bileşenleri KategorisiWall Panel
SolutionsCeiling Panel
Solutions

Dimensions

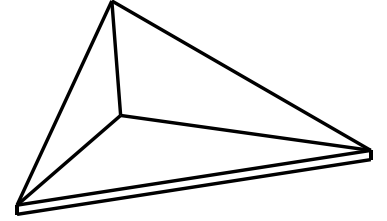

40 cm x 40 cm x 40 cm
60 cm x 60 cm x 60 cm
80 cm x 80 cm x 80 cm

APPLICATION EXAMPLES

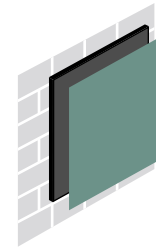
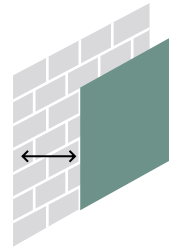
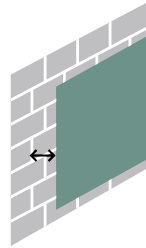
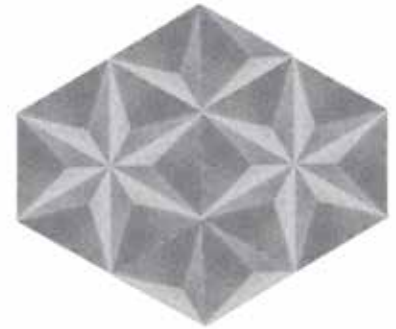

	Standart	30mm GAP	50mm GAP	30mm Rock Wool
NRC	0.81	0.83	0.84	0.85
α_{100}	0.85	0.85	0.85	0.90
Class	B	B	B	A

Ses yutum katsayısı ölçüm ve hesaplamaları DS 500 ve DS 501 için TS EN ISO 354 ve TS EN ISO 11654 standartlarına göre yapılmıştır.
Sound absorption coefficient measurements and calculations according to TS EN ISO 354 and TS EN ISO 11654 standards
for DS 500 & DS 501.

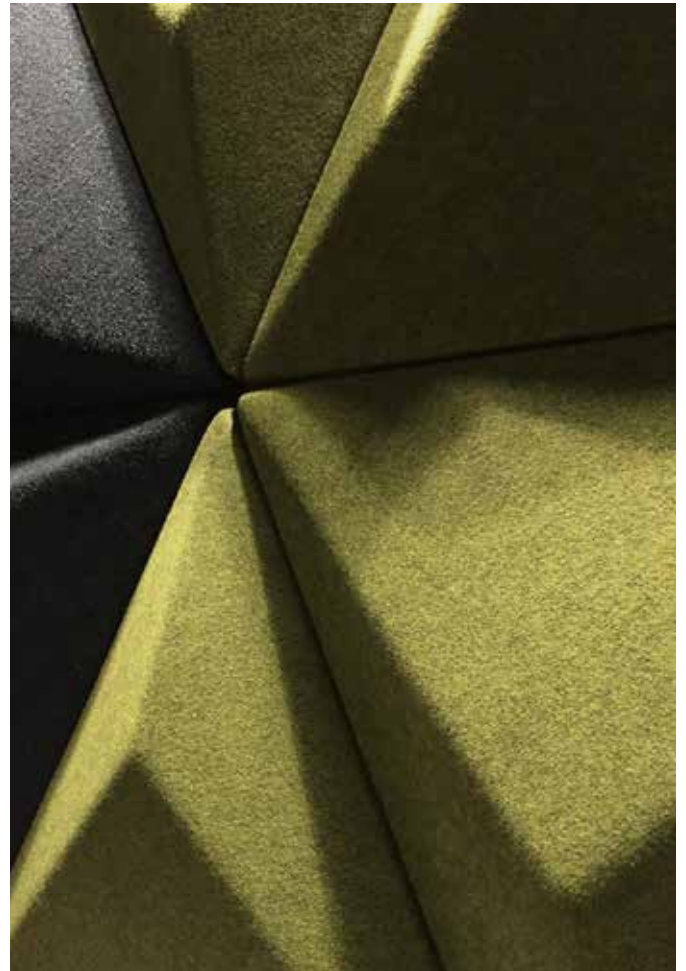
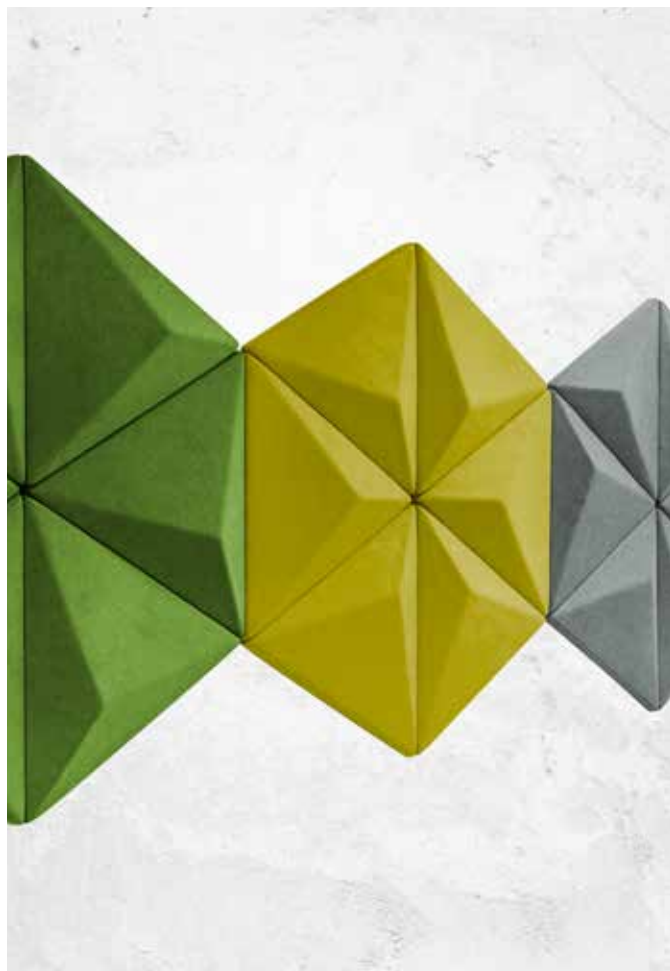

MANTA

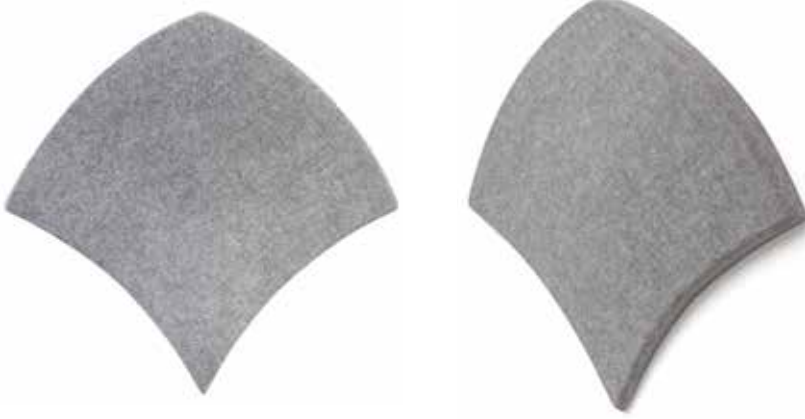
Wall Panel
SolutionsCeiling Panel
Solutions

Dimensions

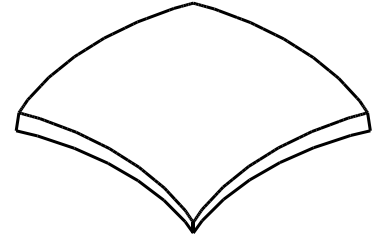

50 cm x 50 cm

APPLICATION EXAMPLES



Standart

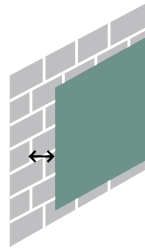

30mm GAP

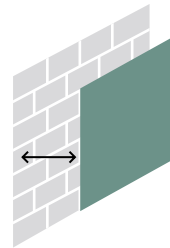

50mm GAP

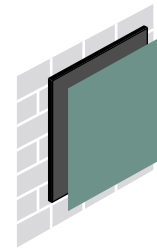

30mm Rock Wool

	Standart	30mm GAP	50mm GAP	30mm Rock Wool
NRC	0.79	0.82	0.83	0.85
α_{100}	0.80	0.85	0.85	0.90
Class	B	B	B	A

Ses yutim katsayısı ölçüm ve hesaplamaları TS EN ISO 354 ve TS EN ISO 11654 standartlarına göre yapılmıştır.
Sound absorption coefficient measurements and calculations according to TS EN ISO 354 and TS EN ISO 11654 standards.



SPIDER WEB

Wall Panel
SolutionsCeiling Panel
Solutions

Dimensions

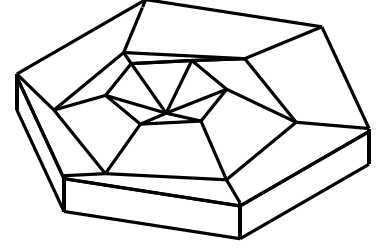
Hexagon 25 cm
Hexagon 38 cm

APPLICATION EXAMPLES

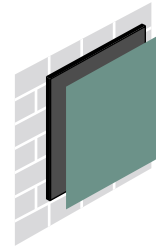
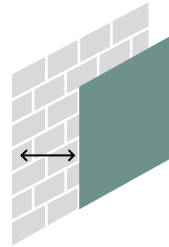
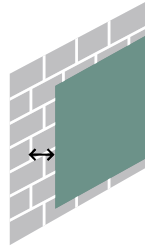
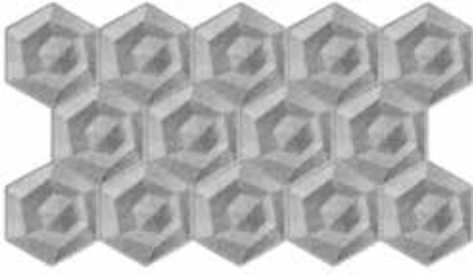

	Standart	30mm GAP	50mm GAP	30mm Rock Wool
NRC	0.81	0.83	0.84	0.85
α_{ω}	0.85	0.85	0.90	0.90
Class	B	B	B	A

Ses yutum katsayısı ölçüm ve hesaplamaları DS 701 için TS EN ISO 354 ve TS EN ISO 11654 standartlarına göre yapılmıştır.
Sound absorption coefficient measurements and calculations according to TS EN ISO 354 and TS EN ISO 11654 standards for DS 701.



PARALLELS



Wall Panel
Solutions

Ceiling Panel
Solutions



Dimensions

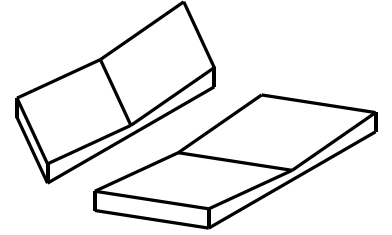

Small 20,00 cm x 40,00 cm (2 Pcs.)

Large 40,00 cm x 80,00 cm (2 Pcs.)

APPLICATION EXAMPLES

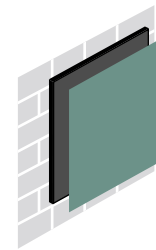
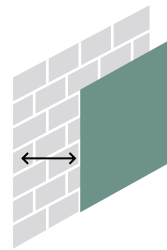
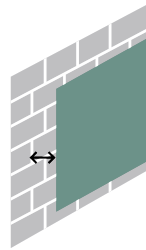
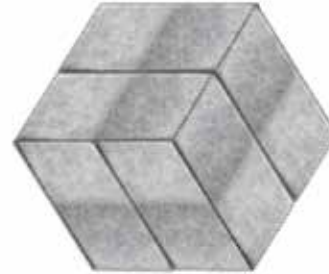

	Standart	30mm GAP	50mm GAP	30mm Rock Wool
NRC	0.78	0.80	0.82	0.85
α_{100}	0.75	0.80	0.85	0.90
Class	C	B	B	A



Mauser



Solutions-ist

FELTOUCH

FlatLine

Modular acoustic solutions for your interior projects!

FlatLine Acoustic Panel Collection is an ideal solution for commercial and public spaces with its alternative dimension options. The Collection promotes a personalized and acoustically balanced workspaces without interruption to a collaborative environment.

Products can be adjust and moved to suit the dynamic requirement of a fast paced modular office. This collection offers acoustic panels, ceiling baffles, table dividers and alternative customizable acoustical solutions.

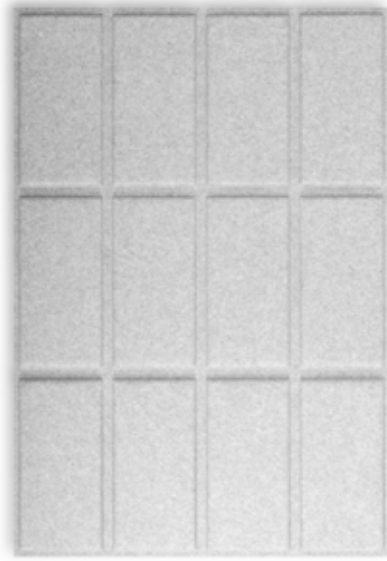

Waffle

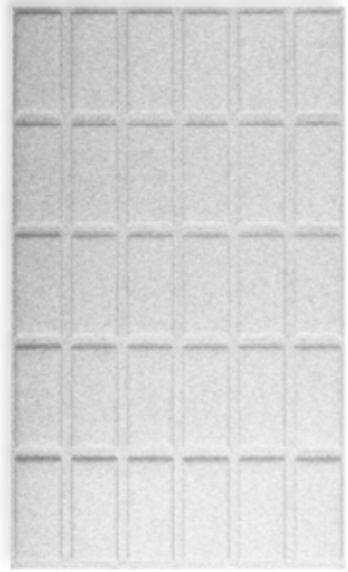

Bitter

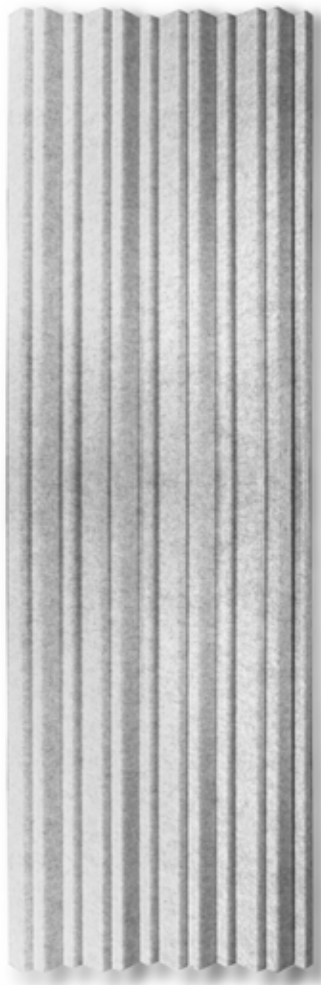

Cracker



Honeycomb



Plain

BITTER

Wall Panel
SolutionsCeiling Panel
SolutionsCustomizable
SolutionsHanging
Solutions

Dimensions

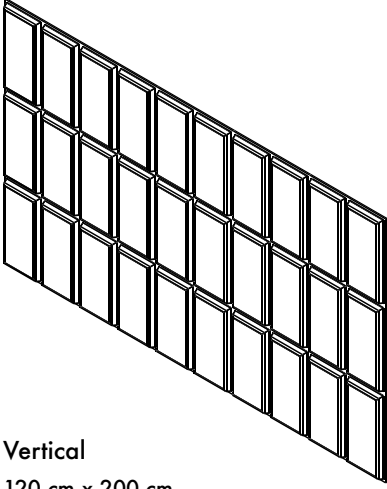
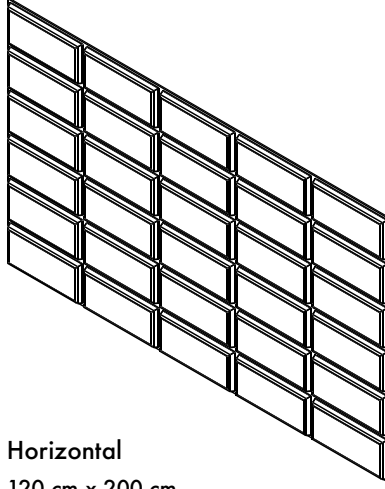
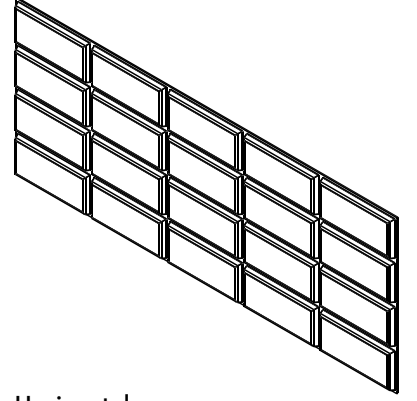
Vertical
120 cm x 200 cmHorizontal
120 cm x 200 cmHorizontal
80 cm x 200 cm

Akıllı montaj sistemi ile mknats veya cırtlı montaj alternatifleri sunar. Diğer montaj şekli ise endüstriyel yapıştırıcılar ile mümkündür.
Smart installation with magnets or velcro. Alternative installation can be available with adhesive.



Standart

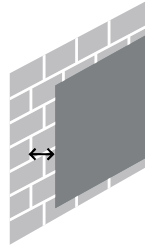

30mm GAP

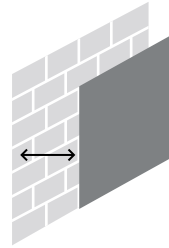

50mm GAP

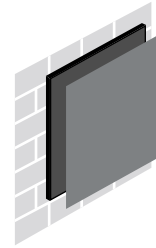

30mm Rock Wool

	Standart	30mm GAP	50mm GAP	30mm Rock Wool
NRC	0.52	0.59	0.64	0.77
α_{100}	0.40	0.45	0.50	0.70
Class	D	D	D	C

Ses yutum katsayısı ölçüm ve hesaplamaları TS EN ISO 354 ve TS EN ISO 11654 standartlarına göre yapılmıştır.
Sound absorption coefficient measurements and calculations according to TS EN ISO 354 and TS EN ISO 11654 standards.



Workinton



Asia Ofis Park



Invent Analytics - İTÜ Teknopark



House 44 Alaçatı

WAFFLE

Wall Panel
SolutionsCeiling Panel
SolutionsCustomizable
SolutionsHanging
Solutions

Dimensions

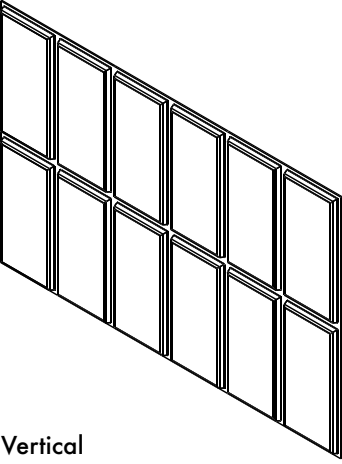
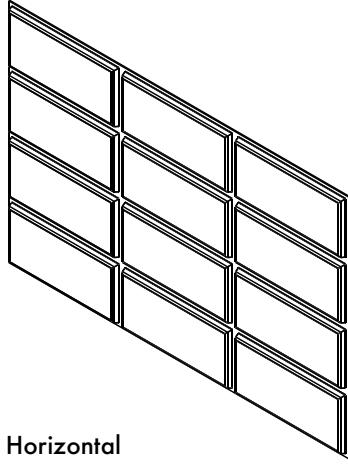
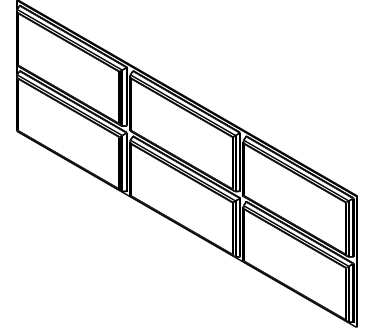
Vertical
120 cm x 180 cmHorizontal
120 cm x 180 cmHorizontal
60 cm x 180 cm

Akıllı montaj sistemi ile mknats veya cırtlı montaj alternatifleri sunar. Diğer montaj şekli ise endüstriyel yapıştırıcılar ile mümkündür.
Smart installation with magnets or velcro. Alternative installation can be available with adhesive.



Standart

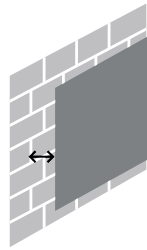

30mm GAP

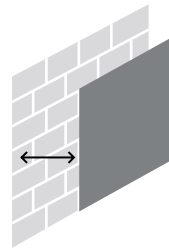

50mm GAP

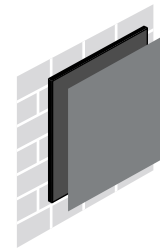

30mm Rock Wool

	Standart	30mm GAP	50mm GAP	30mm Rock Wool
NRC	0.57	0.62	0.65	0.78
α_{100}	0.40	0.50	0.55	0.70
Class	D	D	D	C

Ses yutum katsayısı ölçüm ve hesaplamaları TS EN ISO 354 ve TS EN ISO 11654 standartlarına göre yapılmıştır.
Sound absorption coefficient measurements and calculations according to TS EN ISO 354 and TS EN ISO 11654 standards.



Call Center, Uğur Şeker Mimarlık



Call Center, Uğur Şeker Mimarlık

CRACKER

Wall Panel
SolutionsCeiling Panel
SolutionsCustomizable
SolutionsHanging
Solutions

Dimensions

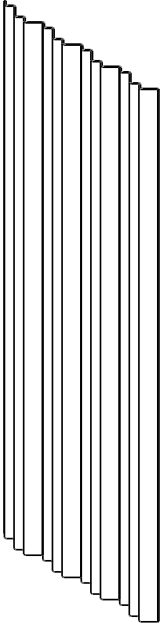

80 cm x 240 cm

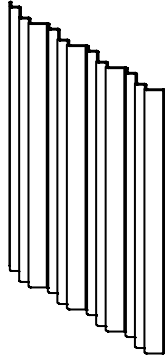

80 cm x 120 cm

Akıllı montaj sistemi ile mıknatıs veya cırtlı montaj alternatifleri sunar.
Diğer montaj şekli ise endüstriyel yapıştırıcılar ile mümkündür.

Smart installation with magnets or velcro.
Alternative installation can be available with adhesive.



Standart

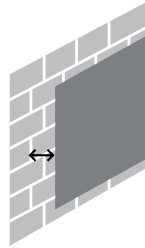

30mm GAP

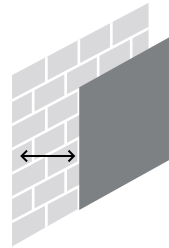

50mm GAP

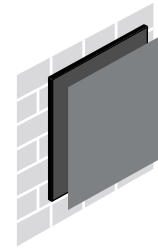

30mm Rock Wool

	Standart	30mm GAP	50mm GAP	30mm Rock Wool
NRC	0.55	0.60	0.62	0.77
α_{100}	0.40	0.45	0.50	0.70
Class	D	D	D	C

Ses yutum katsayısı ölçüm ve hesaplamaları TS EN ISO 354 ve TS EN ISO 11654 standartlarına göre yapılmıştır.
Sound absorption coefficient measurements and calculations according to TS EN ISO 354 and TS EN ISO 11654 standards.



HONEYCOMB

Wall Panel
SolutionsCeiling Panel
SolutionsHanging
Solutions

Dimensions

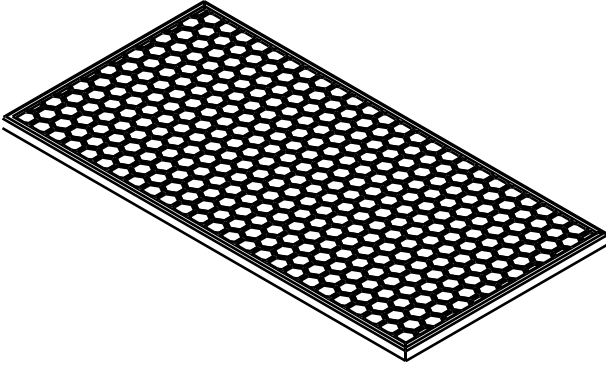

60 cm x 120 cm

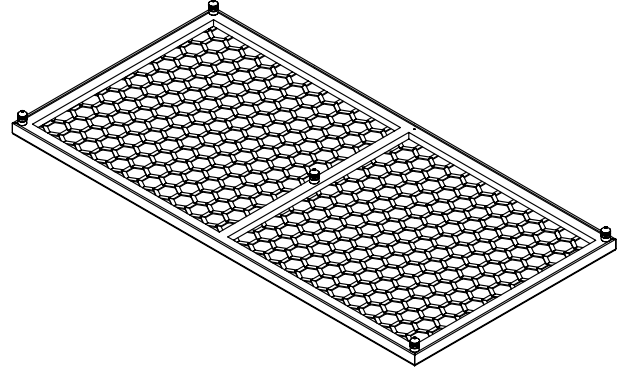

60 cm x 120 cm

Akıllı montaj sistemi ile mıknatıs veya cırtlı montaj alternatifleri sunar. Diğer montaj şekli ise askı tavan sistemi ile mümkündür.
Smart installation with magnets or velcro. Alternative installation can be available with suspended ceiling system.



Standart

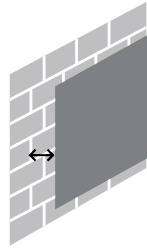

30mm GAP

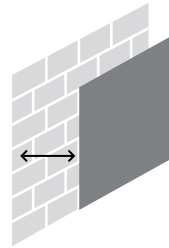

50mm GAP

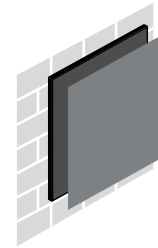

30mm Rock Wool

	Standart	30mm GAP	50mm GAP	30mm Rock Wool
NRC	0.59	0.63	0.66	0.79
α_{100}	0.45	0.50	0.55	0.70
Class	D	D	D	C

Ses yutüm katsayısı ölçüm ve hesaplamaları TS EN ISO 354 ve TS EN ISO 11654 standartlarına göre yapılmıştır.
Sound absorption coefficient measurements and calculations according to TS EN ISO 354 and TS EN ISO 11654 standards.

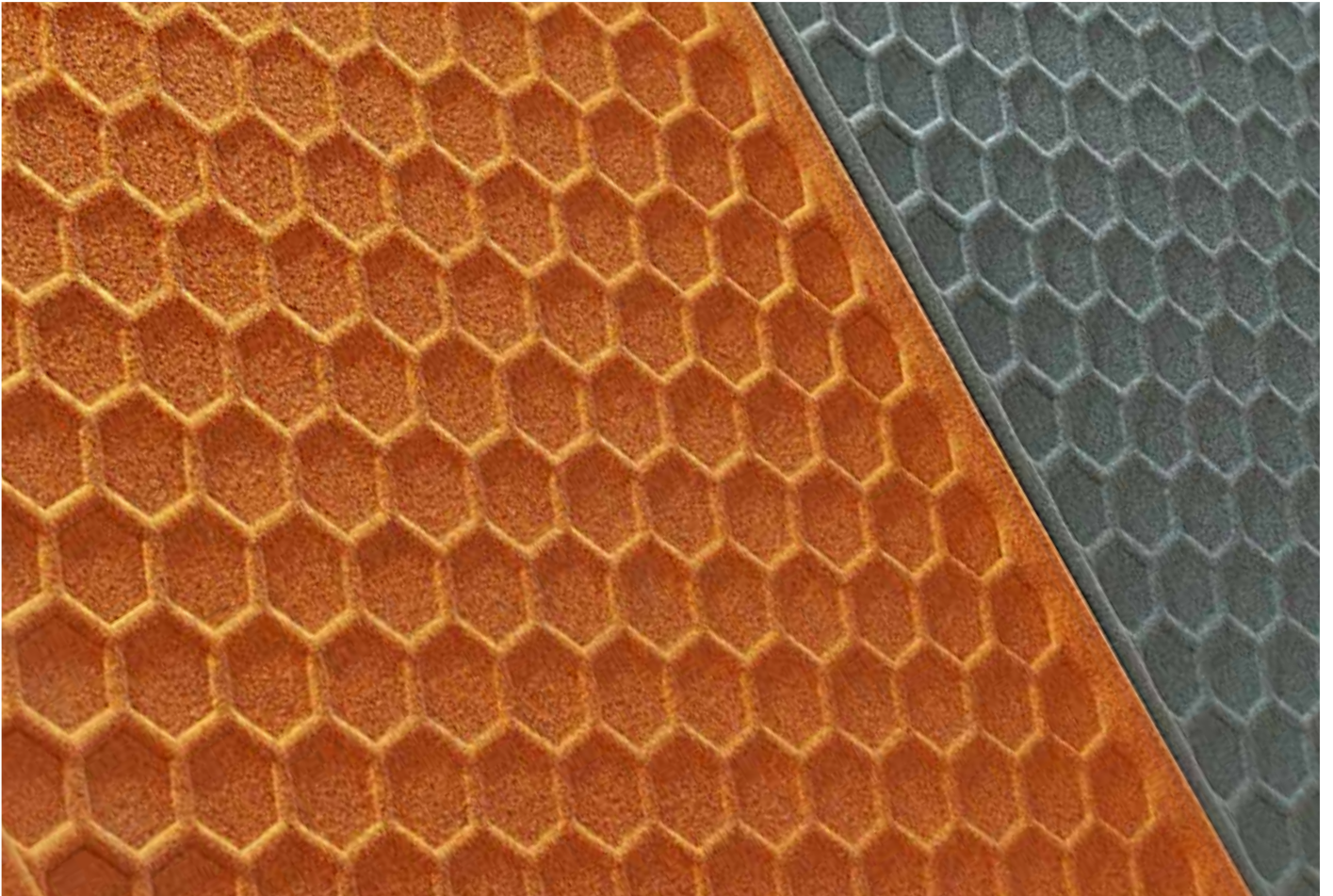

PLAIN

Wall Panel
SolutionsCeiling Panel
Solutions

Dimensions

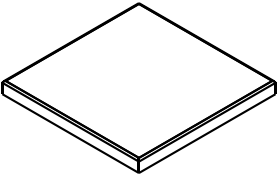
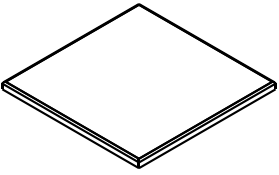
50 cm x 50 cm h: 4 cm
60 cm x 60 cm h: 4 cm50 cm x 50 cm h: 3 cm
60 cm x 60 cm h: 3 cm

Smart installation with magnets or velcro.

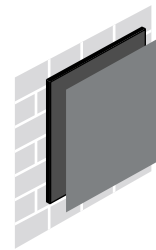
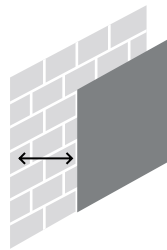
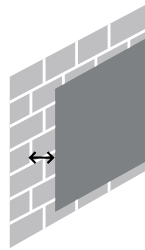

	Standart	30mm GAP	50mm GAP	30mm Rock Wool
NRC	0.54	0.60	0.63	0.76
α_{100}	0.35	0.45	0.50	0.70
Class	D	D	D	C

Ses yutum katsayısı ölçüm ve hesaplamaları TS EN ISO 354 ve TS EN ISO 11654 standartlarına göre yapılmıştır.
Sound absorption coefficient measurements and calculations according to TS EN ISO 354 and TS EN ISO 11654 standards.

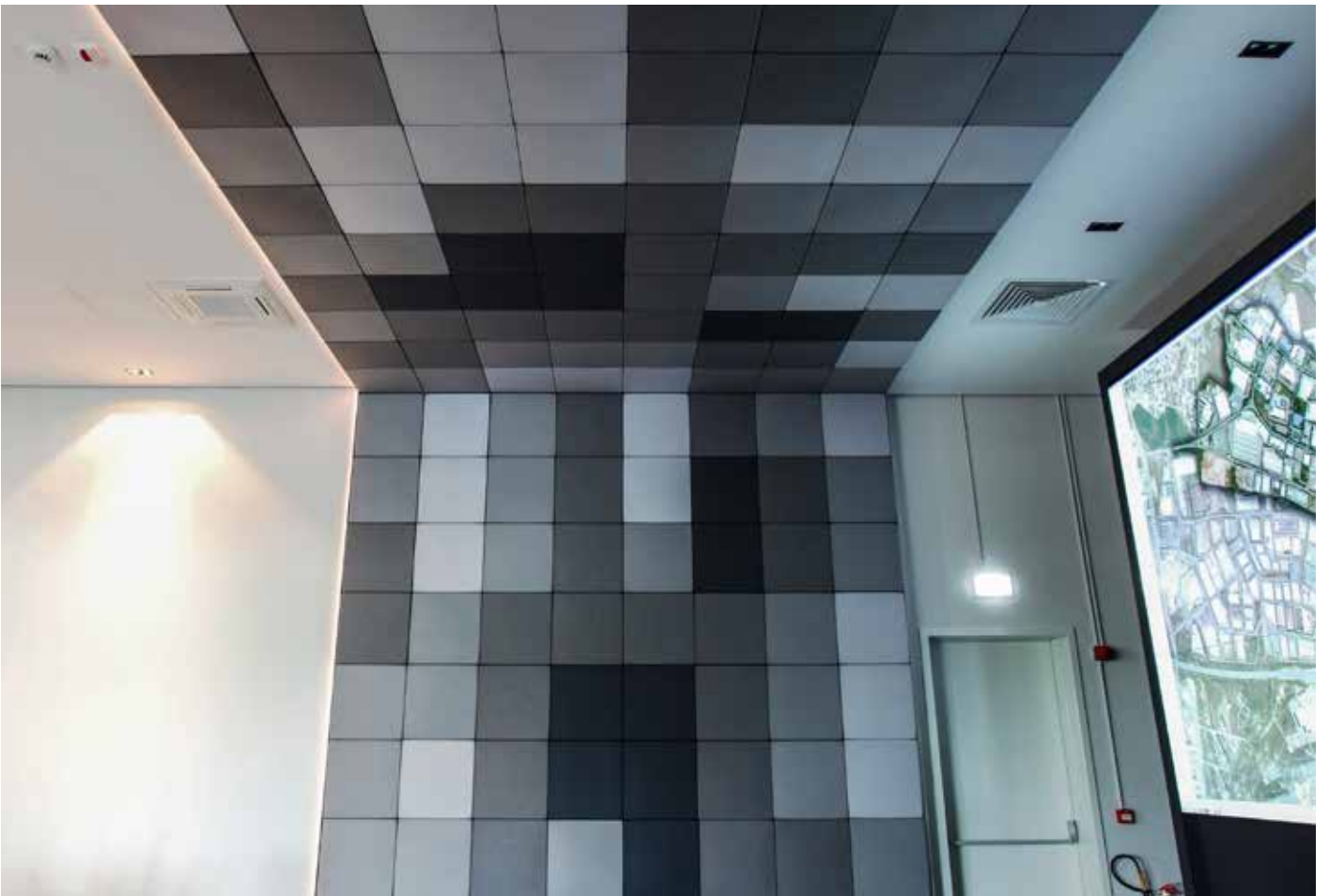



FELTOUCH

Plativity

Meet acoustic solutions that stimulate your imagination!

Plativity Collection offers various products that encourage individual creativity. The creativity idea, which is the starting point of the plativity design, provides a wide range of products that you can choose from our pre-designed templates or by creating new designs of your own.

The Collection offers customizable acoustic solutions from surface cladding, hanging space dividers, ceiling systems to hanging clouds.



Plate

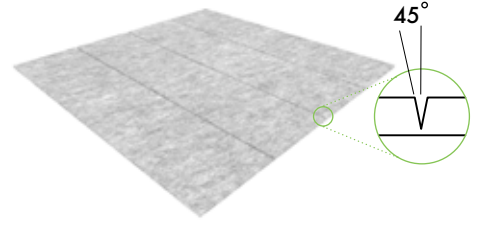

V-Plate

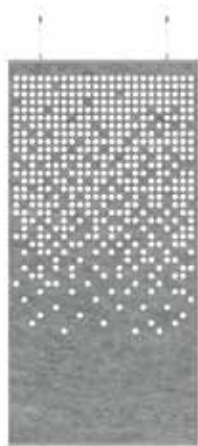

Plativity Mesh



Cloud



Plativity Baffle

PLATE



Cladding
Solutions



Hanging
Solutions



Customizable
Solutions

Dimensions

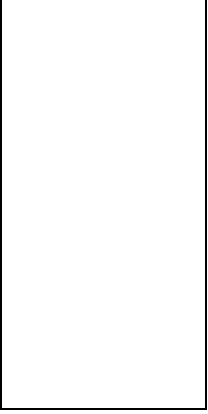

122 cm x 244 cm



142 cm x 184 cm

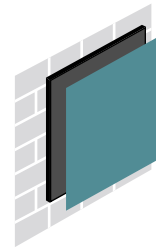
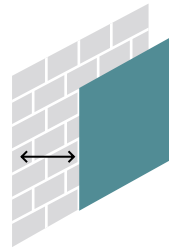
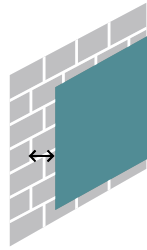

	Standart	30mm GAP	50mm GAP	50mm Rock Wool
NRC	0.23	0.39	0.44	0.76
α_{100}	0.20	0.25	0.35	0.70
Class	E	E	D	C

Ses yutüm katsayısı ölçüm ve hesaplamaları TS EN ISO 354 ve TS EN ISO 11654 standartlarına göre yapılmıştır.
Sound absorption coefficient measurements and calculations according to TS EN ISO 354 and TS EN ISO 11654 standards.



Beylerbeyi Ofis Projesi, Informa Mimarlık

V-PLATE

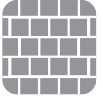

Cladding Solutions



Hanging Solutions



Customizable Solutions

Dimensions

PT 102

120 cm x 240 cm

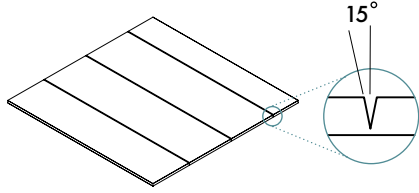

PT 104

120 cm x 240 cm

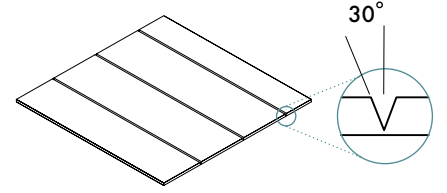

PT 103

120 cm x 240 cm

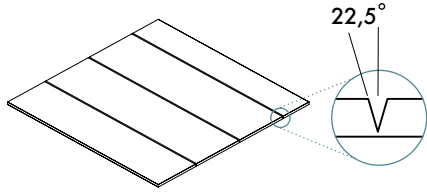

PT 105

120 cm x 240 cm

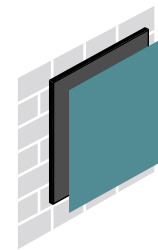
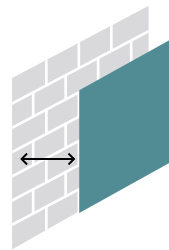
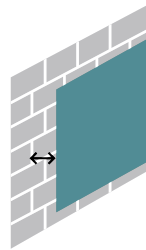
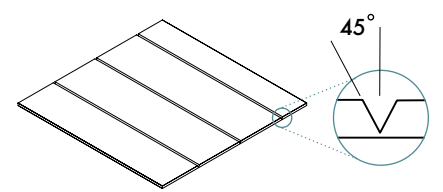

	Standart	30mm GAP	50mm GAP	50mm Rock Wool
NRC	0.23	0.39	0.44	0.76
α_{w0}	0.20	0.25	0.35	0.70
Class	E	E	D	C



MESH



Hanging Solutions



Customizable Solutions

Dimensions



Forest

80 - 120 cm x 240 cm

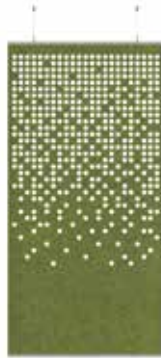

Circles

80 - 120 cm x 240 cm



Plus

80 - 120 cm x 240 cm

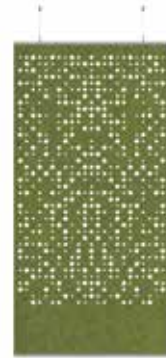

Matrix

80 - 120 cm x 240 cm

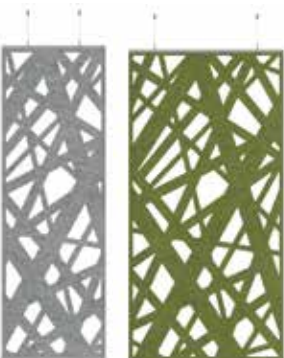

Skew

80 - 120 cm x 240 cm



Rain

80 - 120 cm x 240 cm

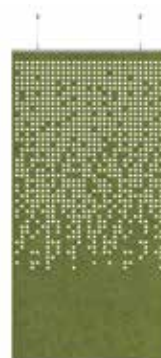

Squares

80 - 120 cm x 240 cm



Matrix Plus

80 - 120 cm x 240 cm



Standart

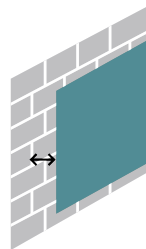

30mm GAP

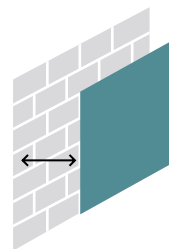

50mm GAP



100mm GAP

	Standart	30mm GAP	50mm GAP	100mm GAP
NRC	0.23	0.40	0.46	0.53
α_{ω}	0.20	0.25	0.35	0.45
Class	E	E	D	D

Sound absorption coefficient measurements and calculations according to TS EN ISO 354 and TS EN ISO 11654 standards for 10-15% perforation.

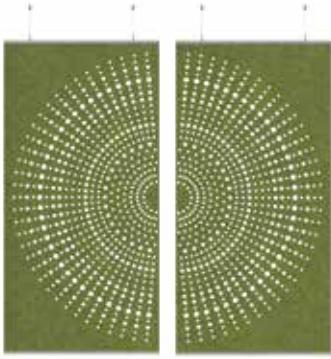

Sun
120 cm x 240 cm

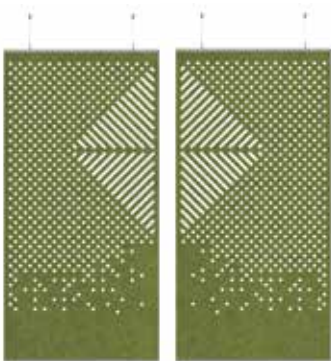

Line
80 - 120 cm x 240 cm

Packed with "U" profile and ceiling mount unit.
Please ask for much more details or alternative
way of usage.



BAFFLE



Ceiling Solutions



Customizable Solutions

Dimensions

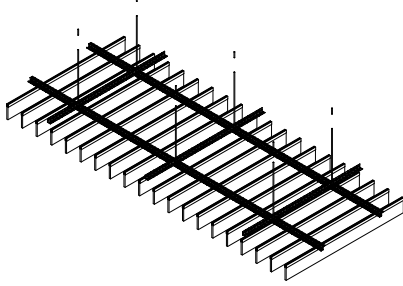

Straight

120 x 300 cm h:12 Gap: 15 cm
180 x 300 cm h:12 Gap: 15 cm
240 x 300 cm h:12 Gap: 15 cm

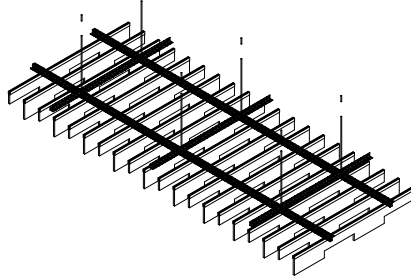

Castle

120 x 300 cm h:12 Gap: 15 cm
180 x 300 cm h:12 Gap: 15 cm
240 x 300 cm h:12 Gap: 15 cm

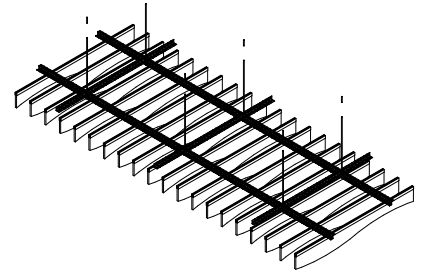

Wave

120 x 300 cm h:12 Gap: 15 cm
180 x 300 cm h:12 Gap: 15 cm
240 x 300 cm h:12 Gap: 15 cm

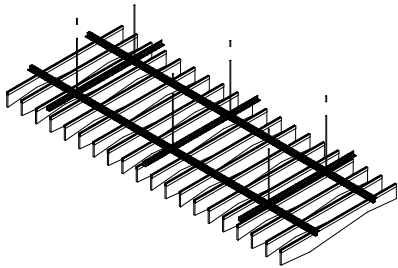

Rate

120 x 300 cm h:12 Gap: 15 cm
180 x 300 cm h:12 Gap: 15 cm
240 x 300 cm h:12 Gap: 15 cm

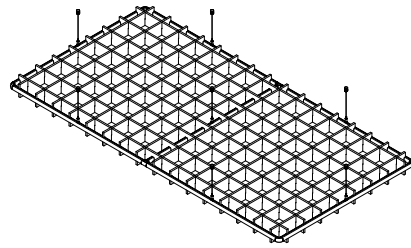

Cassette

120 x 240 cm h:10 Gap: 15 cm

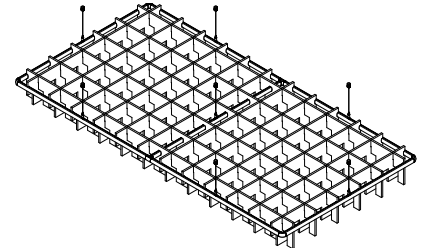

Plus

120 x 300 cm h:10 Gap: 20 cm

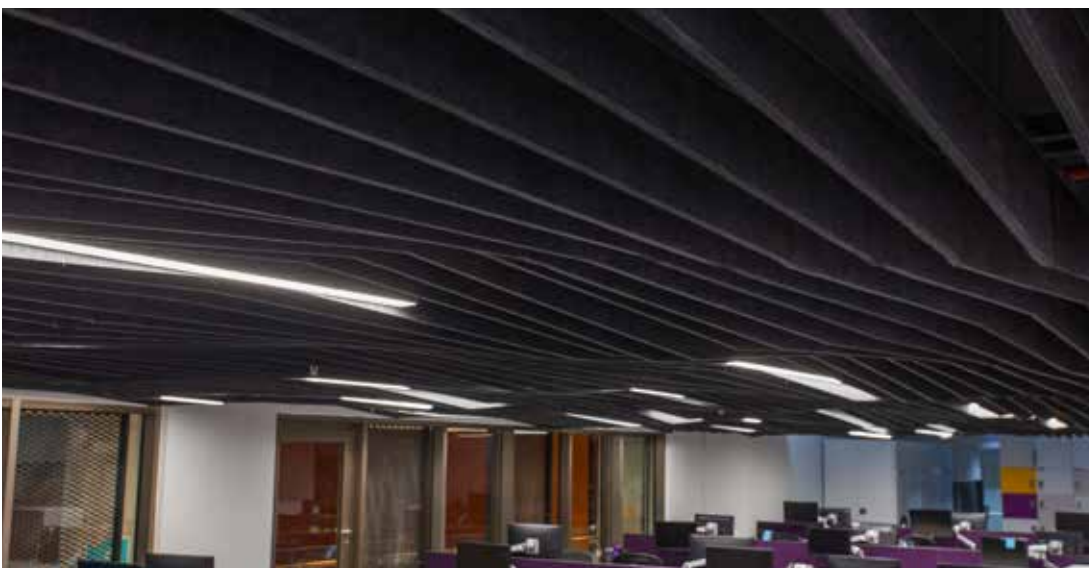

Frekans f (Hz)	A _T 1/3 oktav (m ²)
250	0.1
500	0.9
1000	1.8
2000	3.0
4000	4.6
Sabines (m²)	2.08

Average 250 - 4000 Hz

Sound absorption coefficient measurements and calculations according to TS EN ISO 354 and TS EN ISO 11654 standards.

Packed with "U" profile and ceiling mount unit. Please ask for much more details or alternative way of usage.



CLOUD



Hanging
Solutions



Ceiling
Solutions

Dimensions



Ellipse

120 cm x 120 cm
180 cm x 180 cm



Pebble

102 cm x 132,5 cm



Magnum

120 cm x 120 cm



Astro

120 cm x 240 cm

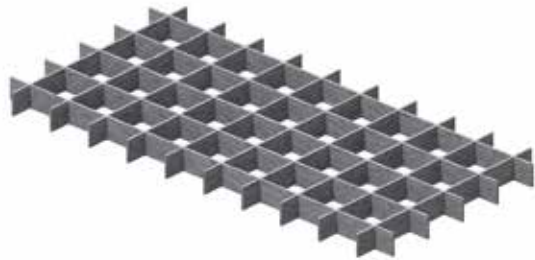

Rectangle

120 cm x 240 cm

Frekans f (Hz)	A _T 1/3 oktav (m ²)
250	0.2
500	1.2
1000	2.4
2000	3.2
4000	4,9
Sabines (m²)	2.38

Average 250 - 4000 Hz

Ses yutüm katsayısı ölçüm ve hesaplamaları
TS EN ISO 354 ve TS EN ISO 11654
standartlarına göre yapılmıştır.

Sound absorption coefficient measurements
and calculations according to TS EN ISO 354
and TS EN ISO 11654 standards.



Borusan Logistics, Feryapı



FELTOUCH

Feltra

Feltra Collection adds too a decorative space design and balances sound especially within office spaces. Feltra is one of the best example of our Fit&Finish concept.

The Collection provides smart solutions for space dividers as a free standing furniture while providing acoustic efficiency at the same time. We are working on product range.

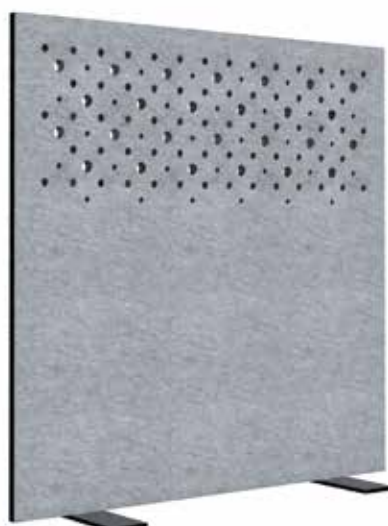

Recta



Flat Cloud



Flat Cloud

RECTA



Furniture Solutions



Customizable Solutions

Dimensions



80 cm x 120 cm



90 cm x 140 cm



120 cm x 120 cm



140 cm x 180 cm

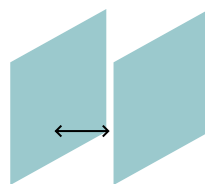

	50mm GAP	50mm Rock Wool
NRC	0.43	0.76
α_{ω}	0.35	0.75
Class	D	C



FLAT CLOUD



Hanging Solutions



Customizable Solutions



Ceiling Solutions

Dimensions



60 cm x 120 cm

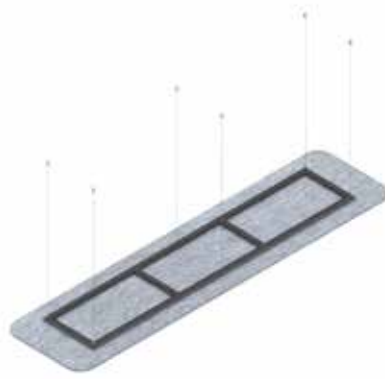

60 cm x 240 cm

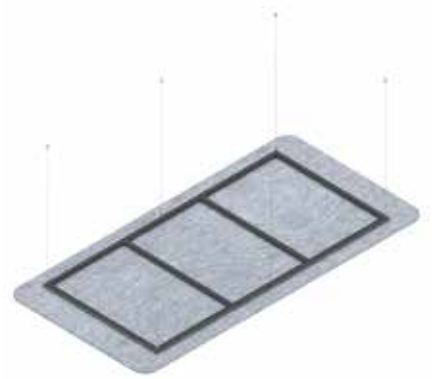

120 cm x 240 cm



90 cm x 140 cm

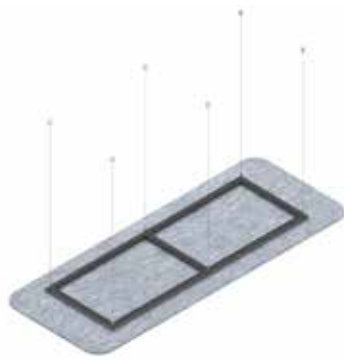

70 cm x 180 cm

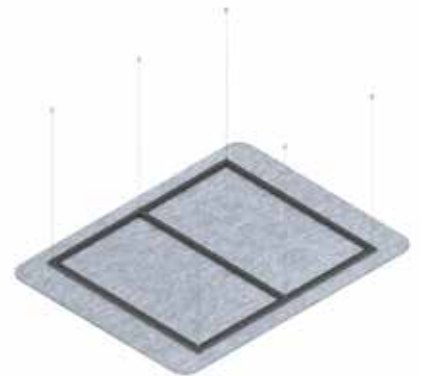

140 cm x 180 cm

Frekans f (Hz)	A_T 1/3 oktav (m ²)
250	2.0
500	3.1
1000	3.6
2000	5.1
4000	6.3
Sabines (m²)	4.02

Average 250 - 4000 Hz

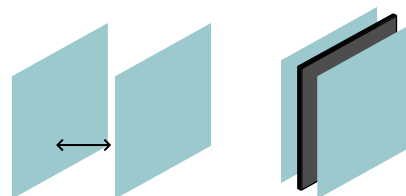

Sound absorption coefficient measurements and calculations according to TS EN ISO 354 and TS EN ISO 11654 standards.



60 cm



80 cm



120 cm



70 cm x 90cm



120 cm x 120cm



FELTOUCH

NewGlow

NewGlow Collection offers a high performance acoustic solution with integrated LED lighting to your interior spaces!

The Collection is the first in our new line of acoustic luminaires which was developed to enhance productivity and creativity.





Topolight



Conic



TOPOLIGHT - CONIC



Lighting
Solutions

Dimensions

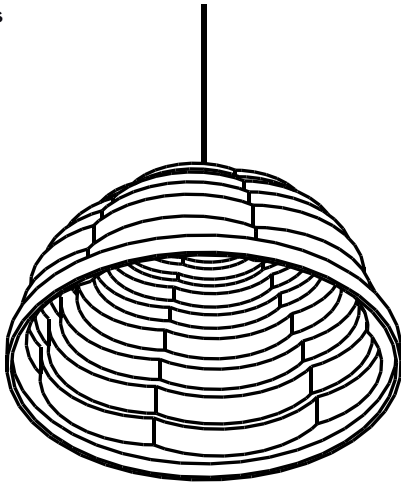

Toplight

R : 85 cm

Dimensions

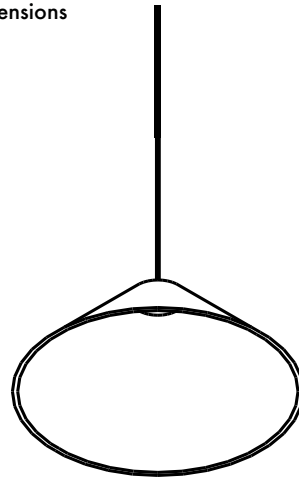

Conic

R : 45 cm

Led bulb and 1,5m cable included. Daylight or white light options are available.



Ömür Restaurant, Yonca Sirmen Mimarlık



Memorial Healthcare Group



Feltouch Products used: V-Plate & Plativity Baffle Straight

Project Name: Prof. Dr. Fuat Sezgin Library - Gülhane Parkı, Designed by: Müze Sergi İşleri , KOOP Architects



Feltouch Products used: V-Plate & Plativity Baffle Straight

Project Name: Prof. Dr. Fuat Sezgin Library, Designed by: Müze Sergi İşleri , KOOP Architects



Feltouch Products used: **V-Plate** & **Plativity Baffle Straight**

Project Name: **Prof. Dr. Fuat Sezgin Library - Gülhane Parkı**, Designed by: **Müze Sergi İşleri , KOOP Architects**



Feltouch Products used: **V-Plate** & **Plativity Baffle Straight**

Project Name: **Prof. Dr. Fuat Sezgin Library - Gülhane Parkı**, Designed by: **Müze Sergi İşleri , KOOP Architects**



Feltouch Products used: **Rhino Triangle & Plate**

Project Name: **Stofa**, Designed by: **We Make Space Denmark**



Feltouch Products used: **Rhino Triangle & Plate**

Project Name: **Mjølner Informatics**, Designed by: **We Make Space Denmark**



Feltouch Products used; **Rhino Triangle**

Project Name: **Sabancı Twin Towers**, Designed by: **Team Fores**



Feltouch Products used; **Rhino Triangle**

Project Name: **Sabancı Twin Towers**, Designed by: **Team Fores**



Feltouch Products used; **Elips Cloud**

Project Name: Mercedes, Designed by: TSC Construction



Feltouch Products used; **Rhino Square**

Project Name: Mercedes, Designed by: TSC Construction



Feltouch Products used; **Recta**

Project Name: **Coworking Space** Designed by: **Narsist Architects**



Feltouch Products used; **Recta**

Project Name: **Coworking Space** Designed by: **Narsist Architects**



Feltouch Product used; **Cracker**

Project Name: **University Classroom**



Feltouch Product used; **Spider web&Plate**

Project Name; **Office Meeting Room**



Feltouch Product used; **Custom Mesh**

Project Name: **Quick Insurance**, Designed by: **Taba Architects**



Feltouch Product used; **Astro & Ellipse Cloud**

Project Name: Zurich Insurance, Designed by: Erginoglu&Calislar Architects - Ecarth



Feltouch Product used; **Custom Mesh Plate**

Project Name: Zurich Insurance



Feltouch Product used; **Astro & Ellipse Cloud**

Project Name: Zurich Insurance



Feltouch Product used; **Ellipse Cloud**

Project Name: Divan Headquarters, Designed by: Feltouch Design Team



Feltouch Product used; **Ellipse Cloud**

Project Name: Divan Headquarters, Designed by: Feltouch Design Team



Feltouch Product used; **Flat Cloud**

Project Name: **Lila Kağıt**, Designed by: **Bakırküre Architects**

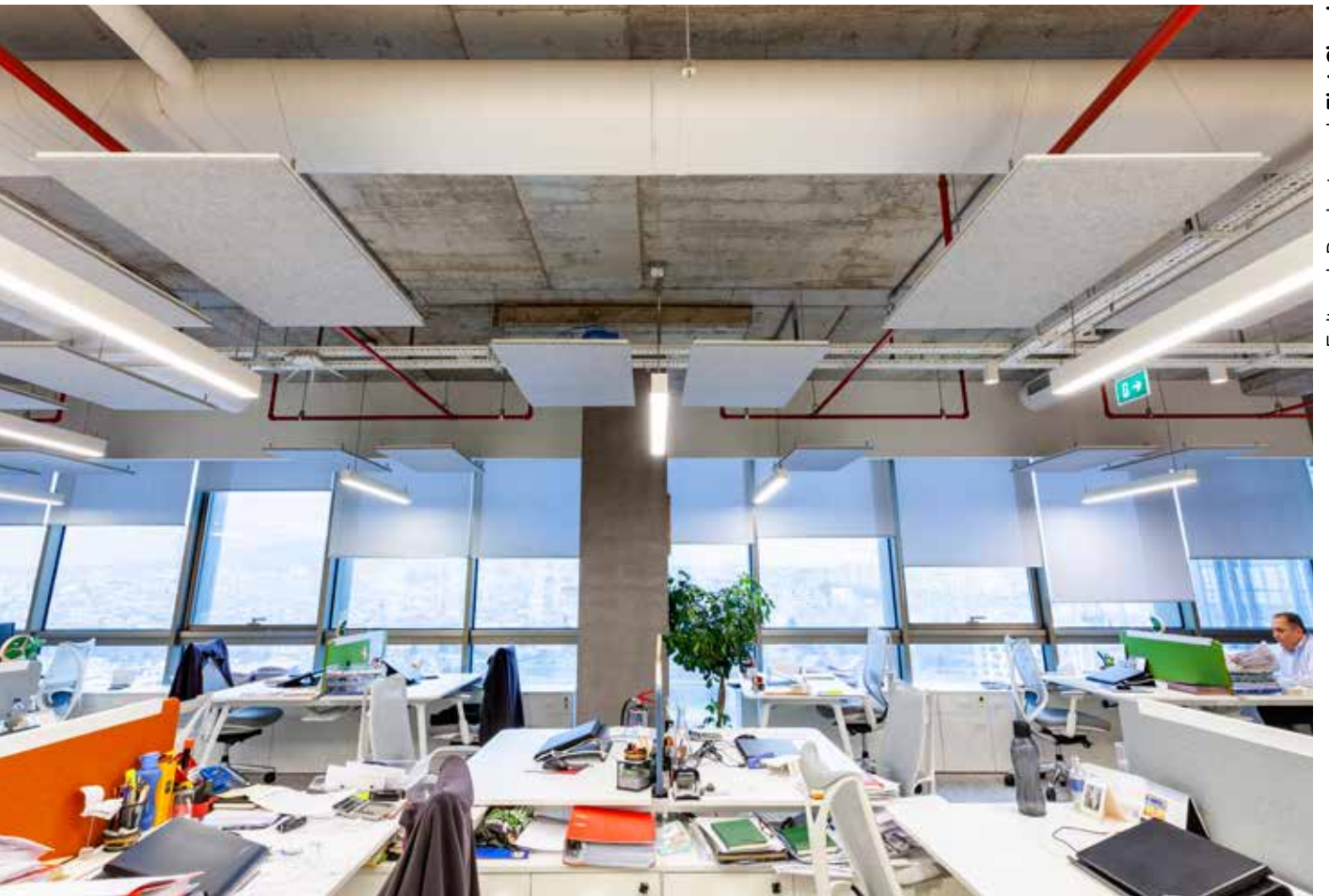

Feltouch Product used; **Flat Cloud**

Project Name: **Lila Kağıt**, Designed by: **Bakırküre Architects**



Feltouch Product used; **Recta**

Project Name: **Tam Factoring**, Designed by: **Editds Architects - Pinar Ersu**



Feltouch Product used; **Bitter&Spider web**

Project Name: **Tam Factoring**, Designed by: **Editds Architects - Pinar Ersu**



Feltouch Products used; **Ellipse Cloud, Custom Mesh**

Project Name: **Tam Factoring**, Designed by: **Editds Architects - Pinar Ersu**



Feltouch Product used; **Rhino Square**

Project Name: **Tam Factoring**



Feltouch Product used; **Rhino Square**

Project Name: **Tam Factoring**



Feltouch Product used; **V-Plate&Spider Web**

Project Name: **Oniki Law Office**, Designed by: **Yonca Sirmen Architects**



Feltouch Product used; **Mesh Rain&Cracker**



Feltouch Product used; **Spider Web**



Feltouch Product used: Spider Web

Project Name: Chef's Bistro, Designed by: Yonca Sirmen Architects



Feltouch Product used: Cracker

Project Name: Chef's Bistro - Austria, Designed by: Yonca Sirmen Architects



Feltouch Product used; **Plativity Rate Baffle & Bitter**

Project Name: **Asia Ofis Park - Yemekhane**, Designed by: **Atölye A Architects**



Feltouch Products used; **Bitter Cloud, Frequency & Plate**

Project Name: **Pozitif Radyo Unique Maslak**, Designed by: **Autoban 212 Architects**



Feltouch Products used: **Conic & Plativity Custom Baffle**

Project Name: **Ömür Restaurant**, Designed by: **Yonca Sirmen Architects**



Feltouch Product used: **Plativity Mesh**

Project Name: **YPU Istanbul**, Designed by: **Pinar Sahin Kocabas**



Feltouch Product used; Astro Cloud & Flat Cloud & Mesh Squares

Project Name: Workinton Designed by: DNA Architects



Feltouch Product used; Astro Cloud



Feltouch Product used; Flat Cloud



Feltouch Product used; Frequency & Flat Cloud

Project Name: Workinton Designed by: DNA Architects



Feltouch Product used; Flat Cloud

Project Name: Workinton



Feltouch Product used; Flat Cloud

Project Name: Workinton



Feltouch Product used; **Rhino Square**

Project Name: **Workinton** Designed by: **DNA Architects**

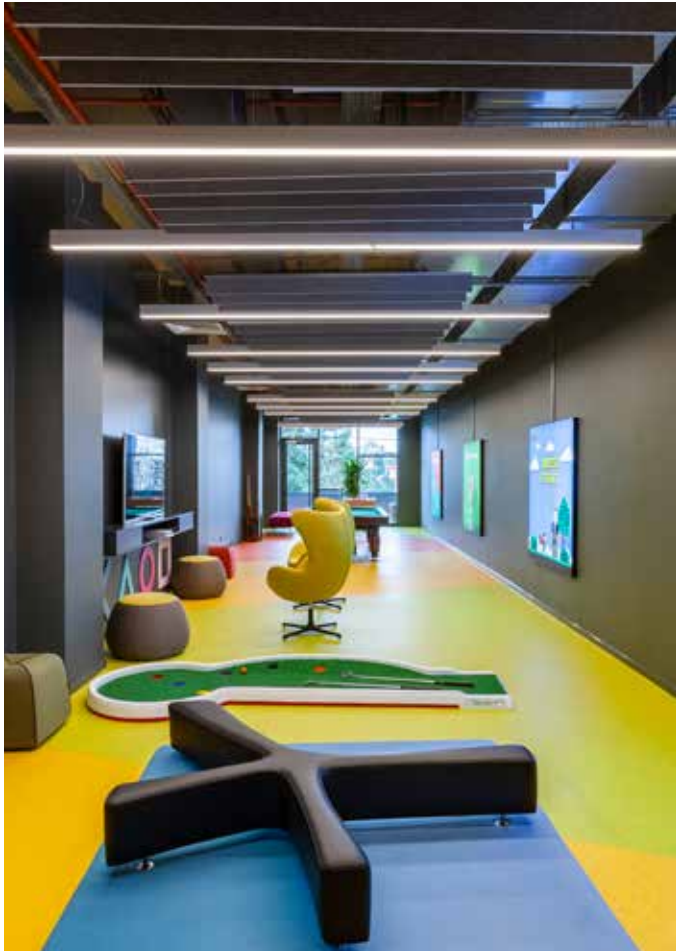

Feltouch Product used; **Plativity Baffle Straight**



Feltouch Product used; **Recta**



Feltouch Product used; **Bitter**

Project Name: **Workinton** Designed by: **DNA Architects**



Feltouch Product used; **Mesh Squares**

Project Name: **Workinton** Designed by: **DNA Architects**



Feltouch Product used; Plativity Baffle Straight

Project Name: ODTU - CoZone Designed by: Studio13 Architects



Feltouch Product used; Plativity Baffle Straight

Project Name: ODTU - CoZone Designed by: Studio13 Architects



Feltouch Product used; **Plativity Baffle Straight**

Project Name: ODTU - CoZone Designed by: Studio13 Architects



Feltouch Product used; **Plativity Baffle Straight**

Project Name: ODTU - CoZone Designed by: Studio13 Architects



Feltouch Product used; **Plate**

Project Name: ODTU - CoZone Designed by: **Studio13 Architects**



Feltouch Product used; **Plativity Baffle Straight**



Feltouch Product used; **Plativity Baffle Straight**



Feltouch Product used; **Cracker**

Project Name: ODTU - CoZone Designed by: Studio13 Architects



Feltouch Product used; **Cracker**

Project Name: ODTU - CoZone Designed by: Studio13 Architects



Feltouch Product used; **Rhino Triangle**

Project Name: Hasbro, Designed by: Informa Architects



Feltouch Product used; **Plate**

Project Name: Hasbro, Designed by: Informa Architects



Feltouch Product used; **Plate**

Project Name: **Hasbro**, Designed by: **Informa Architects**



Feltouch Product used; **Plate**

Project Name: **Hasbro**



Feltouch Product used; **Plate**

Project Name: **Hasbro**



Feltouch Product used; **Flat Cloud**

Project Name: **Elekta**, Designed by: **Mimarte Architects**

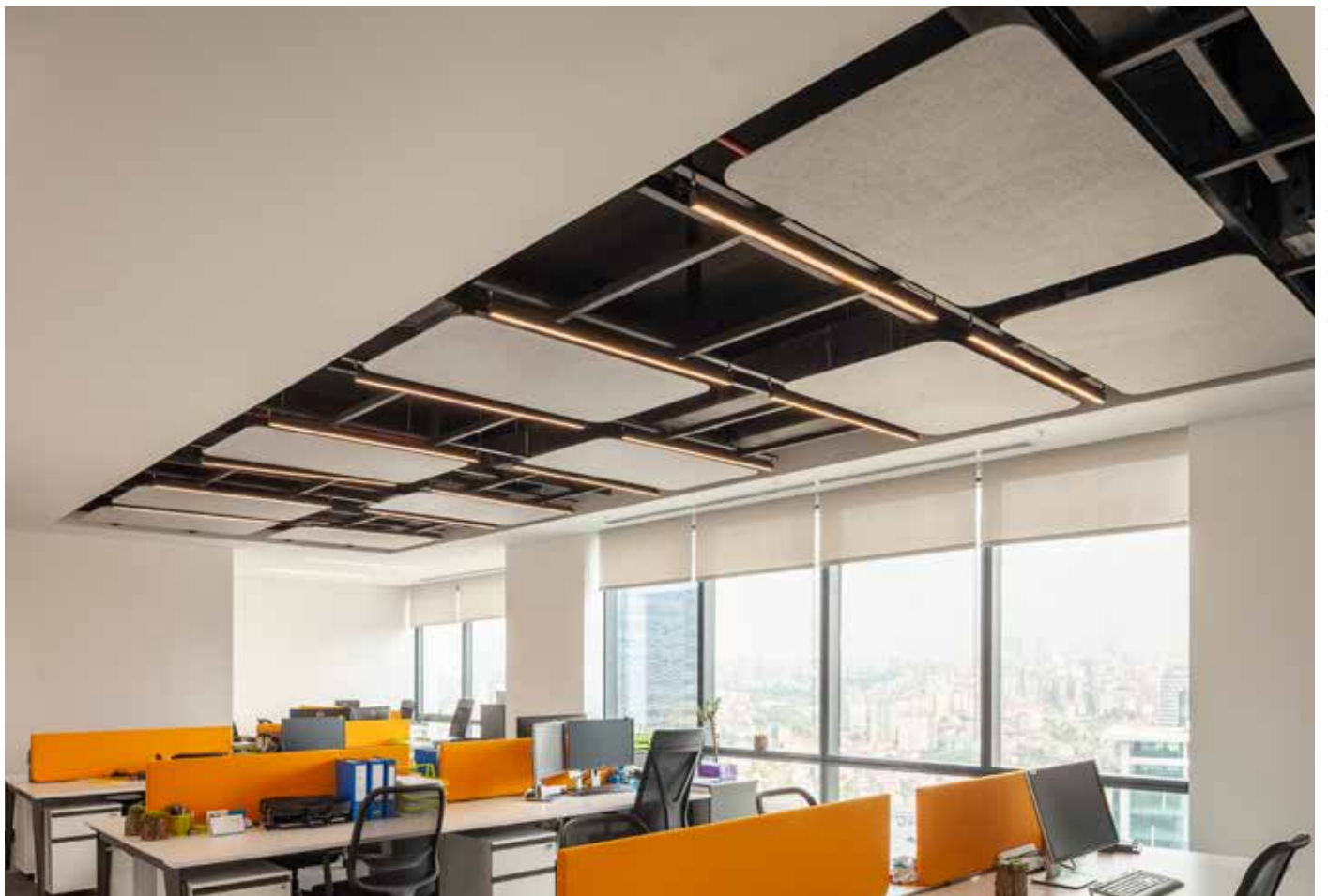

Feltouch Product used; **Flat Cloud**

Project Name: **Elekta**, Designed by: **Mimarte Architects**



Feltouch Product used; **V-Plate**

Project Name: **Elekta**, Designed by: **Mimarte Architects**



Feltouch Product used; **V-Plate**

Project Name: **Elekta**, Designed by: **Mimarte Architects**

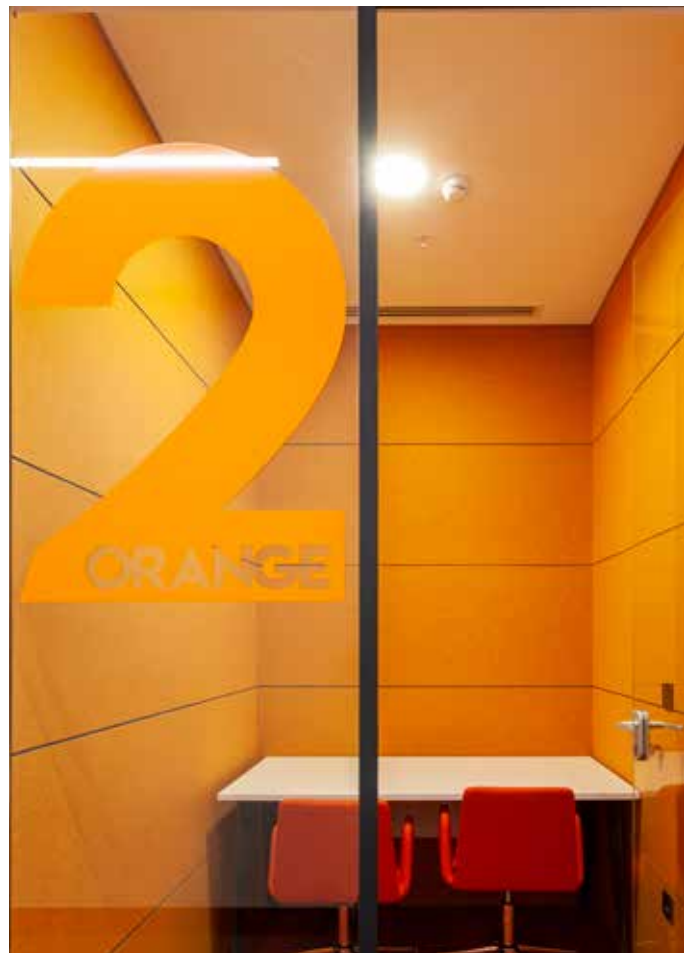

Feltouch Product used; **V-Plate**

Project Name: **Elekta**, Designed by: **Mimarte Architects**



Feltouch Products used; **Plate**

Project Name: Aksa Jenarator - Kazancı Holding , Designed by: Puar Interior Design



Feltouch Products used; **Plate**

Project Name: Aksa Jenarator - Kazancı Holding , Designed by: Puar Interior Design



Feltouch Product used; V-Plate

Project Name: Ajinomoto, Designed by: Studio13 Architects



Feltouch Product used; V-Plate

Project Name: Ajinomoto, Designed by: Studio13 Architects



Feltouch Product used: **Plate**

Project Name: **TEB Bank - BNP PARIBAS**, Designed by: **Bakirküre Architects**



Feltouch Product used: **Plate**

Project Name: **Meeting Room**, Designed by: **SPM Architects**



Feltouch Product used; **Plate**

Project Name: Willis Towers Watson

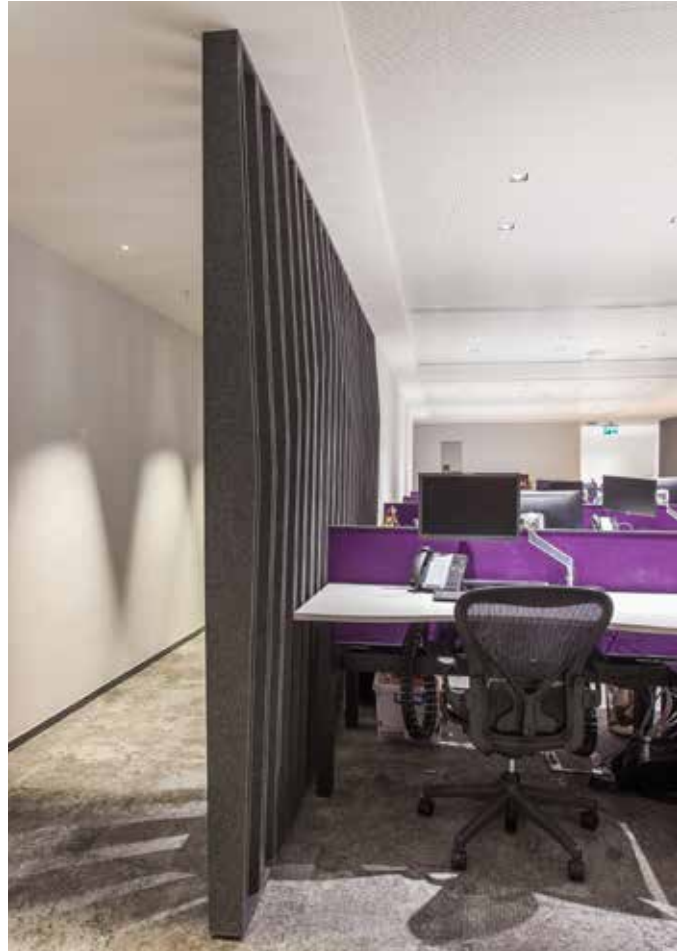

Feltouch Product used; **Plate**

Project Name: Willis Towers Watson



Feltouch Product used; **Plativity Baffle**

Project Name: Willis Towers Watson, Designed by: Sebnem Kursad



Feltouch Product used: **Plativity Baffle Rate**

Project Name: **Office Building**, Designed by: **Erginoglu&Calislar Architects - Ecarch**



Feltouch Product used: **Plativity Baffle Rate**



Feltouch Product used; **Plativity Baffle Rate**

Project Name: **Office Building**, Designed by: **Erginoglu&Calislar Architects - Ecarch**



Feltouch Product used; **Plativity Baffle Rate**

Project Name: **Office Building**, Designed by: **Erginoglu&Calislar Architects - Ecarch**



Feltouch Product used; **Plativity Baffle Straight**

Project Name: Büyük Klüp D'orient Cafe, Designed by: IPD Architects



Feltouch Product used; **Plativity Custom Baffle**

Project Name: Büyük Klüp D'orient Cafe, Designed by: IPD Architects



Feltouch Product used; **Rhino Square**

Project Name: Orka - Damat&Tween, Designed by: Orka Design Team



Feltouch Product used; **Rhino Square**

Project Name: Orka - Damat&Tween, Designed by: Orka Design Team



Feltouch Product used; **Recta**

Project Name: **Bayer Istanbul Headquarters**, Designed by: **Ünder Architects**



Feltouch Product used; **Recta**

Project Name: **Bayer Istanbul Headquarters**, Designed by: **Ünder Architects**



Feltouch Product used: **Toplight**

Project Name: **Memorial Healthcare Group**, Designed by: **Memorial Design Team**



Feltouch Product used: **Plate**

Project Name: **Societe General Istanbul Headquarters**, Designed by: **BE Architects**



Feltouch Product used; **Bitter**

Project Name: **School Project**, Designed by: **Yard Construction**



Feltouch Product used; **Bitter**

Project Name: **School Project**, Designed by: **Yard Construction**



Feltouch Product used; **Bitter**

Project Name: **Office Ceiling**, Designed by: **Feltouch Design Team**



Feltouch Product used; **Bitter**

Project Name: **Protek**, Designed by: **Feltouch Design Team**



Feltouch Product used; **Octopus**

Project Name: **Siemens R&D Campus** Designed by: **Feltouch Design Team**



Feltouch Product used; **Plativity Mesh**

Project Name: **Siemens R&D Campus** Designed by: **Feltouch Design Team**



Feltouch Product used; **Plativity Mesh**

Project Name: **Siemens R&D Campus** Designed by: **Feltouch Design Team**

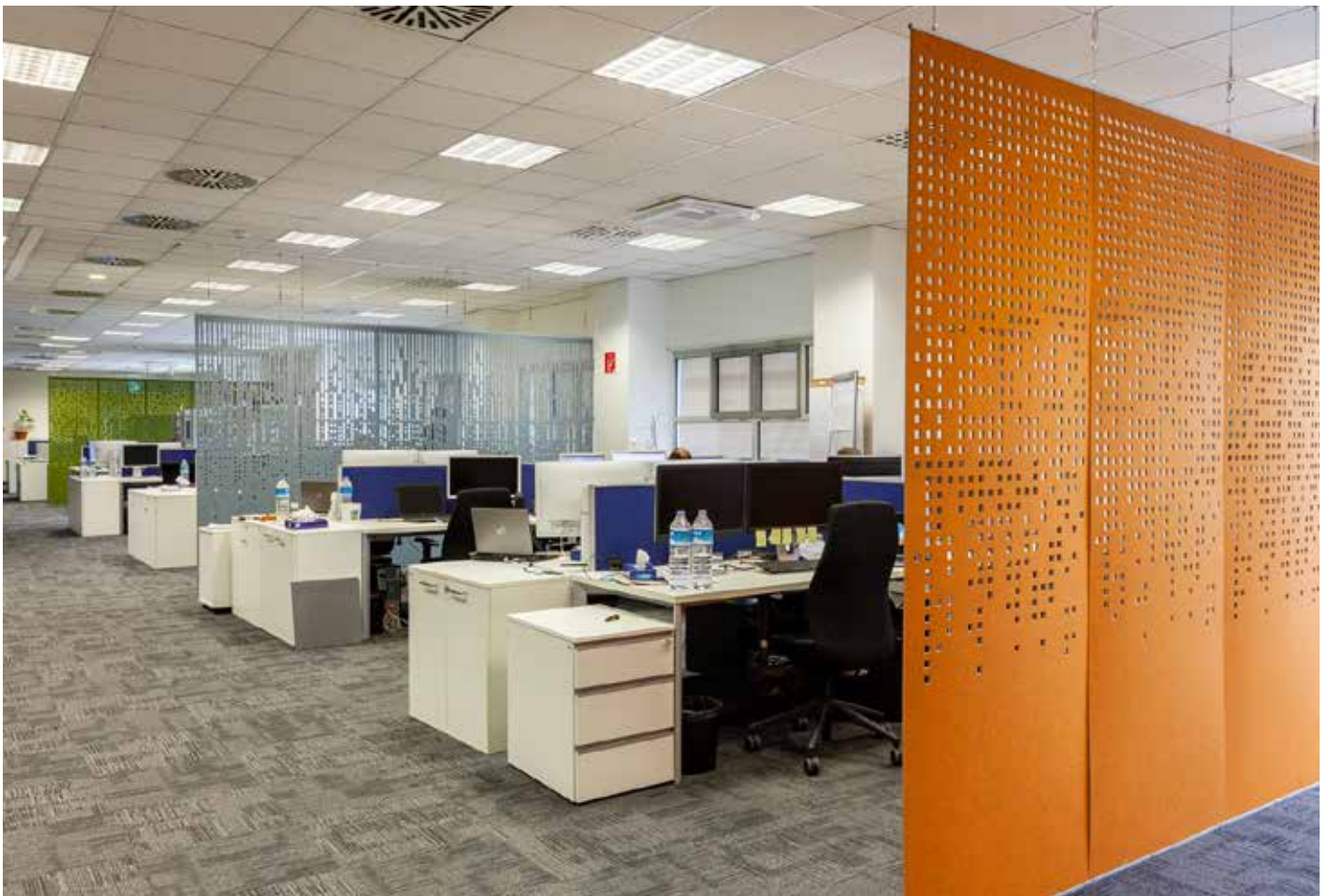

Feltouch Product used; **Plativity Mesh**

Project Name: **Siemens R&D Campus** Designed by: **Feltouch Design Team**

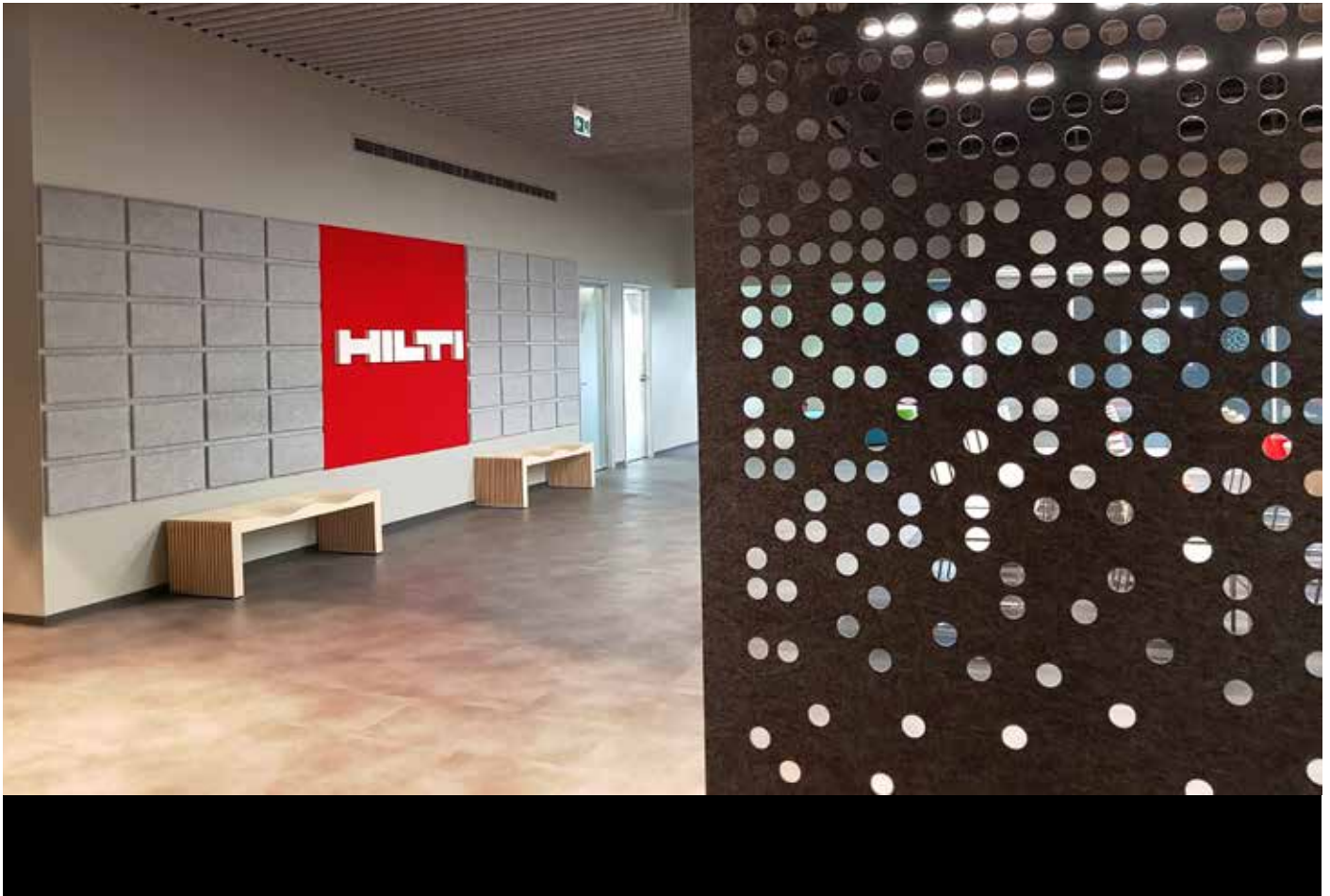

Feltouch Products used; **Waffle, Plate, Baffle Straight & Mesh Circles**

Project Name: Hilti, Designed by: Arkista Architects



Feltouch Product used; **Mesh Circles**

Project Name: Hilti, Designed by: Arkista Architects



Feltouch Product used: **Rhino Square**

Project Name: ITU Campus, FitOut by: Sessan



Feltouch Product used: **Rhino Triangle**

Project Name: **BMG Australia**

DecoSound



Wall Panel Solutions



Ceiling Panel Solutions

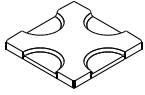

Batura
50x50
60x60

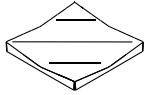

Frequency
50x50
60x60



Octopus
50x50
60x60

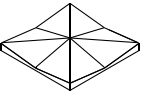

Rhino Square
50x50
60x60

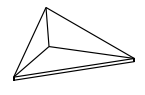

Rhino Triangle
Eq. 40
Eq. 60
Eq. 80

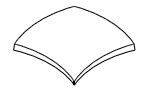

Manta
50x50

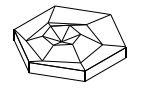

Spider Web
Hex. 25
Hex. 38

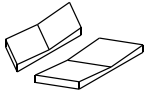

Parallels
20 x 40 (2 Pcs.)
40 x 80 (2 Pcs.)

FlatLine



Wall Panel Solutions



Ceiling Panel Solutions



Hanging Solutions



Customizable Solutions

Bitter

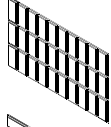

Vertical
120x200

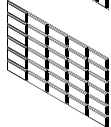

Horizontal
120x200

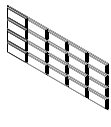

Horizontal
80x200

Waffle

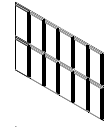

Vertical
120x180

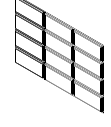

Horizontal
120x180

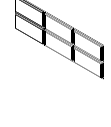

Horizontal
60x180

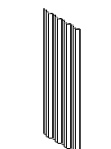

Cracker
80x240
80x120

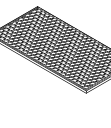

Honeycomb
60x120

Plain

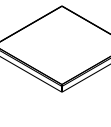

50x50 - 4
60x60 - 4

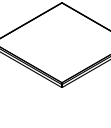

50x50 - 3
60x60 - 3

Feltra



Furniture Solutions



Customizable Solutions



Hanging Solutions

Recta



80x120



90x140



120x120



120x140

Flat Cloud

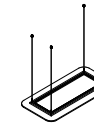

120x240
60x120
90x140

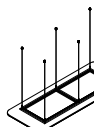

60x240
70x180

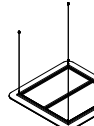

70x90
120x120
140x180

NewGlow



Lighting Solutions



Toplight
Ø 85



Conic
Ø 45



All dimensions are in centimeters (cm)

Plativity



Cladding Solutions



Hanging Solutions



Furniture Solutions



Ceiling Solutions



Customizable Solutions

Plate

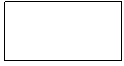

120x240



140x180

V-Plate

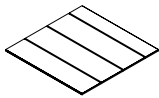

120x240 15° - 22,5° - 30° - 45°
140x180 15° - 22,5° - 30° - 45°

Baffle

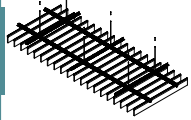

Straight
120/180/240x300 h:12 Gap:15

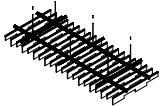

Castle
120/180/240x300 h:12 Gap:15

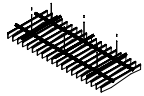

Rate
120/180/240x300 h:12 Gap:15

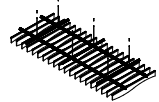

Wave
120/180/240x300 h:12 Gap:15

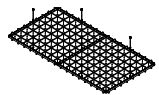

Cassette & Plus
120x240

Cloud

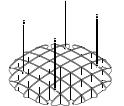

Ellipse
120x120
180x180

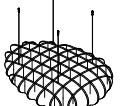

Pebble
102x133

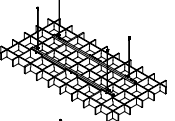

Rectangle
120x240

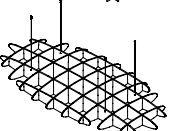

Astro
120x240

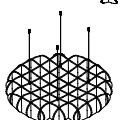

Magnum
120x120

Mesh

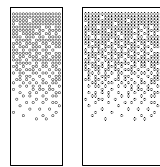

Circles
80x240
120x240

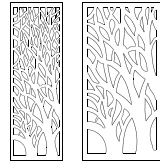

Forest
80x240
120x240

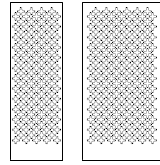

Plus
80x240
120x240

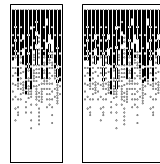

Rain
80x240
120x240

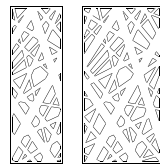

Skew
80x240
120x240

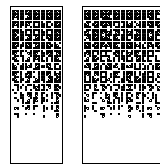

Squares
80x240
120x240

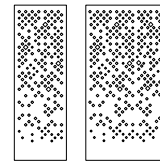

Matrix
80x240
120x240

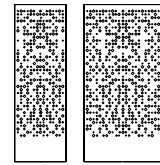

Matrix Plus
80x240
120x240

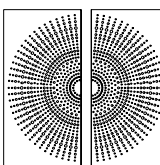

Sun
120x240

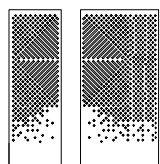

Line
80x240
120x240

WE



COLLECT



CONVERT



CREATE



LOVE
EARTH

PET's Perfect Conversion

FELTOUCH gives a second chance to PET packaging waste

What happens in this journey?

- Waste PET is condensed into big blocks
- It is broken down into small fibers
- Washed and Cleaned
- After drying process fibers come to life
- PET Fibers become FELT by using traditional mechanical pinning (non-woven) technique
- Finally, it becomes a unique acoustical product within Feltouch designs
- The life cycle is sustainable because they can be recycled again

We offer environmentally friendly acoustical & decorative products to interiors.



ANTRASIT GREY
FLT01



SILVER GREY
FLT02

camira SONUS



VOICE
FHR02



AUDIO
FHR06



BEAT
FHR03



MELODY
FHR07



SOUL
FHR13



RAP
FHU11



SONG
FHR01



POP
FHR09



ACOUSTIC
FHR12

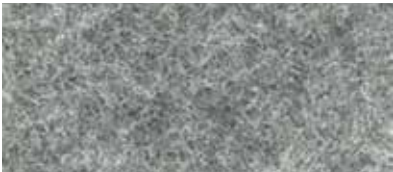

MUSIC
FHU04



CHORUS
FHR17



LYRIC
FHU15



CLASSICAL
FHU14



VOCAL
FHU08



VERSE
FHR16



AMP
FHR05



JINGLE
FHU18

Please ask for color options.

FELTOUCH

Aesthetically Acoustic Solutions!

feltouch.com

info@feltouch.com

 [feltouch](#)

 [feltouchacoustics](#)

 [feltouch](#)

